

# GRATING PRODUCTS

PROGrid® and PROGrate®

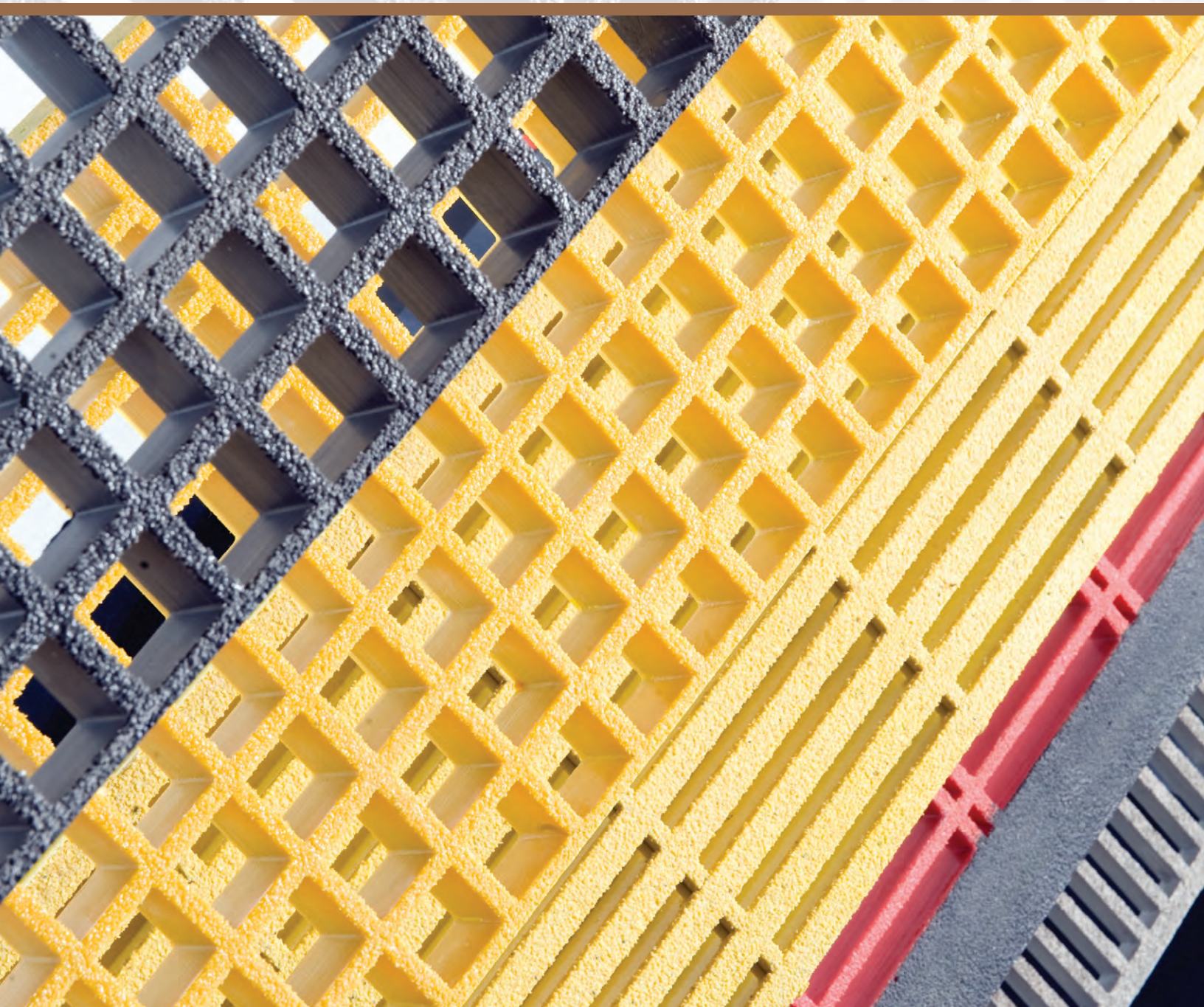



# PROGrid® and PROGrate® Grating Products

## CONTENTS

### GRATING PRODUCTS

- 4 PROGrid® Molded Grating
- 10 PROGrid® High Load Capacity Molded Grating
- 12 PROGrate® Pultruded Grating

### ACCESSORIES

- 16 PROGrid® Molded & PROGrate® Pultruded Stair Treads/Stair Tread Covers
- 20 Fasteners
- 22 Grating Pedestals
- 24 PROForms® Composite Embedment Angle

### SPECIAL ORDER PRODUCTS

- 26 PROGrid® Molded Grating
- 28 PROGrate® Pultruded Grating
- 37 PROGrate® Heavy Duty Pultruded Grating
- 44 PROGrate® Pultruded VGBA Certified Grating
- 46 PROGrate® Pultruded Phenolic Grating

### REFERENCE

- 48 Product Availability
- 51 Chemical Resistance Guide





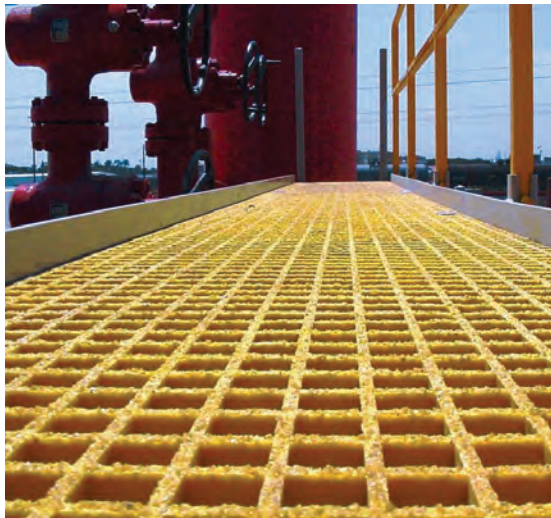

#### APPLICATIONS

- Floor systems
- Walkways
- Work platforms
- Stairs
- Ramps
- Trench covers
- Catwalks

#### FEATURES

- Corrosion resistant
- Slip-resistant gritted top surface
- Strong yet lightweight
- Low coefficient of expansion and contraction

#### BENEFITS

- Reduced maintenance and replacement costs
- Enhanced workplace safety
- Reduced installation costs
- Dimensionally stable in many environments

## STRONG, LIGHTWEIGHT AND CORROSION-RESISTANT

Want the strength of steel without the weight? Our fiberglass-reinforced polymer (FRP) grating products have the advantage. Our grating is corrosion-resistant, it's fire-retardant, and it has low conductivity. It's available with anti-slip coating for worker safety. And it's easy to install with standard tools.

Whether you simply need grating panels or a complete FRP system with handrails, stairs and platforms, we have the solution to match. In addition to our products, we offer in-house design, engineering and fabrication capabilities to meet your project needs.





## PROGrid® Molded Grating

Proven corrosion resistance is just one of the benefits of our PROGrid® molded grating. It's strong, lightweight and performs reliably for years, even in extreme conditions. Top surface options also provide excellent slip resistance for worker safety.

### **Long Service Life**

The high resin-to-glass ratio (approximately 65% resin to 35% glass by weight) provides excellent service life, even in the most demanding applications.

### **Less Waste**

Interwoven square mesh construction provides bi-directional strength, so you can cut grating to fit and make the most efficient use of each panel.



## Available Resin Systems

PROGrid® molded grating is available in three resin systems, each providing different levels of corrosion protection. All three resin systems meet Class 1 Flame Spread Rating per ASTM E-84 test standards.

**GP:** A general-purpose orthophthalic polyester resin system that offers good corrosion resistance at an economical price. Standard colors: Yellow and Light Gray

**IFR:** A premium-grade isophthalic polyester resin system that provides excellent corrosion protection. Standard colors: Green, Yellow, Dark Gray and Light Gray

**VFR:** A vinylester resin system that provides the highest level of corrosion protection. Standard colors: Orange and Dark Gray

## Available Top Surfaces

PROGrid® molded grating is available in square or rectangular mesh patterns with either Meniscus or Grit-Top slip-resistant top surfaces.

**Grit-Top:** Quartz grit anti-slip surface

**Meniscus:** Concave, half-moon cross section with no grit

UV Inhibitor  
Fire Retardant  
Polyester or  
Vinylester Resin

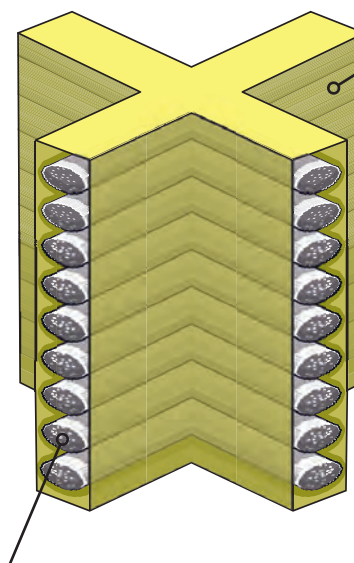

Uniform Glass Strands Bonded With Resin

## Available Grid Dimensions

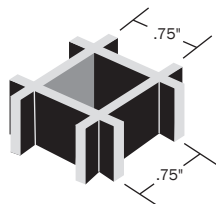

**1" or 1½" thick,  
¾" x ¾" Square Grid**

Bearing bars 0.25" thick  
Open area of 69%

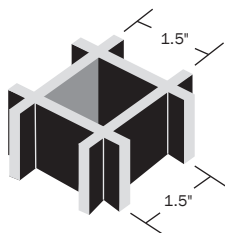

**1" or 1½" thick,  
1½" x 1½" Square Grid**

Bearing bars 0.25" thick  
Open area of 69%

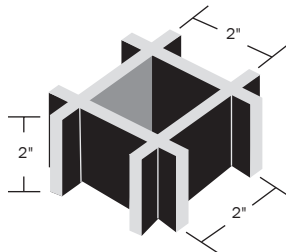

**2" thick,  
2" x 2" Square Grid**

Bearing bars 0.3125" thick  
Open area of 71%

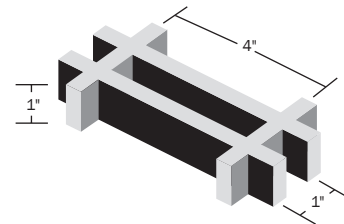

**1" thick,  
1" x 4" Rectangular Grid**

Bearing bars 0.25" thick  
Open area of 68%

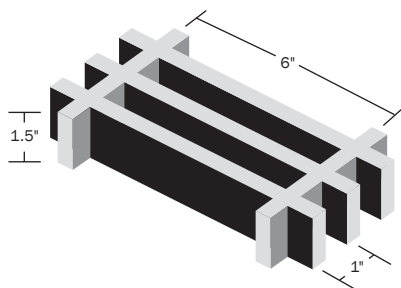

**1½" thick,  
1" x 6" Rectangular Grid**

Bearing bars 0.6" thick  
Open area of 38%

### Available Panel Sizes\*

1" x ¾" x ¾" (Square)	4' wide x 12' long
1½" x ¾" x ¾" (Square)	4' wide x 12' long
1" x 1½" x 1½" (Square)	3' wide x 10' long / 4' wide x 8' long / 4' wide x 12' long
1½" x 1½" x 1½" (Square)	3' wide x 10' long / 3' wide x 12' long / 4' wide x 12' long
2" x 2" x 2" (Square)	4' wide x 12' long / 5' wide x 12' long
1" x 1" x 4" (Rectangular)	12' wide x 4' long / 10' wide x 3' long
1½" x 1" x 6" (Rectangular)	4' wide x 12' long

\*Note: Not all panel sizes are stocked in every resin series and color. Check website for availability.



# PROGrid® Molded Grating Load and Deflection Data

## CONCENTRATED LOAD

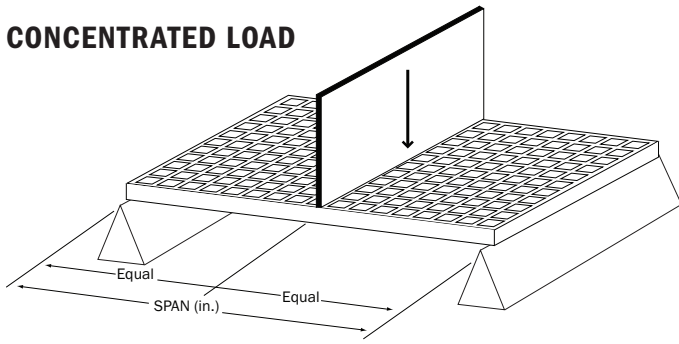

## UNIFORM LOAD

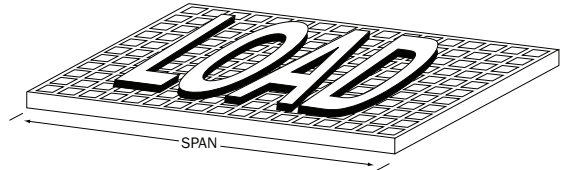

1. The following tables were developed in accordance with the test method developed by the Fiberglass Grating Manufacturers Council (FGMC) of the American Composites Manufacturers Association (ACMA) for the Fiberglass Grating Standard.
2. The designer should not exceed MAXIMUM RECOMMENDED load at any time. MAXIMUM LOAD represents a 4:1 factor of safety on ULTIMATE CAPACITY. ULTIMATE CAPACITY represents MAX LOAD observed at initial fracture.
3. Walking loads for maintenance traffic are typically a live load of 50 PSF. Deflections for worker comfort are typically limited to 0.375" (3/8") or SPAN divided by 120 under full live load. For a firmer feel under full live load or a line load 250 lb/ft of width, limit deflections to 0.25" (1/4") or SPAN divided by 200.
4. The loads represented are for STATIC LOAD CONDITIONS at ambient temperature. Deflections for impact loads or dynamic loads will MULTIPLY the deflections shown by 2. Long term loads will result in added deflection due to creep in the material and will require higher factors of safety to ensure acceptable performance.
5. Deflections are limited to 0.5" (1/2") as recommended by the Fiberglass Grating Manufacturers Council of the American Composites Manufacturers Association.

**1" x 1" x 4"**  
**Rectangular Grid**  
**1" Thick**  
**68% Open**

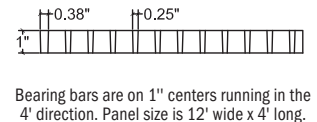
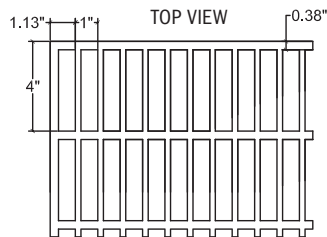

Span (inches)	CONCENTRATED LOAD in lb/ft of width								Max Load (lb/ft)	Apparent EI x 10 <sup>6</sup> (lb-in <sup>2</sup> )
	50	100	150	200	250	500	1000	2000		
12	0.004	0.008	0.012	0.016	0.020	0.040	0.079		1834	0.45
18	0.012	0.024	0.036	0.049	0.061	0.122	0.243		1419	0.50
24	0.028	0.056	0.083	0.111	0.139	0.278	0.555		961	0.52
30	0.053	0.107	0.160	0.213	0.266	0.533			769	0.53
36	0.090	0.181	0.271	0.362	0.452				641	0.54
42	0.138	0.276	0.413	0.551	0.689				549	0.56
46	0.178	0.355							501	0.57

Span (inches)	UNIFORM LOAD in lb/ft <sup>2</sup>								Max Load (lb/ft <sup>2</sup> )	Apparent EI x 10 <sup>6</sup> (lb-in <sup>2</sup> )
	50	100	150	200	250	500	1000	2000		
12	0.002	0.005	0.007	0.010	0.012	0.025	0.050	0.099	3668	0.45
18	0.011	0.023	0.034	0.046	0.057	0.114	0.228		1892	0.50
24	0.035	0.069	0.104	0.139	0.174	0.347			961	0.52
30	0.083	0.167	0.250	0.333	0.416				615	0.53
36	0.170	0.339	0.509	0.679					427	0.54
42	0.301	0.603							314	0.56
46	0.430								287	0.57

Properties Per Foot of Width	# of Bars	Load Bar Width	Bar Centers	Weight/sq ft
A = 2.69 in <sup>2</sup> I = 0.22 in <sup>4</sup> S = 0.45 in <sup>3</sup>	12	0.25"	1"	2.61



**1" x 1½" x 1½"**  
**Square Grid**  
**1" Thick**  
**69% Open**

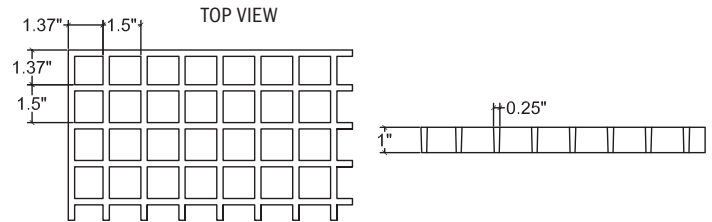
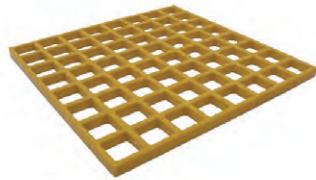

Span (inches)	CONCENTRATED LOAD in lb/ft of width								Max Load (lb/ft)	Apparent EI x 10 <sup>6</sup> (lb-in <sup>2</sup> )
	50	100	150	200	250	500	1000	2000		
12	0.006	0.011	0.017	0.023	0.029	0.057	0.114		1189	0.31
18	0.018	0.035	0.053	0.071	0.089	0.177			934	0.34
24	0.040	0.080	0.120	0.160	0.199	0.399			668	0.36
30	0.076	0.152	0.228	0.304	0.380				534	0.37
36	0.128	0.256	0.384	0.512	0.640				360	0.38

Span (inches)	UNIFORM LOAD in lb/ft <sup>2</sup>								Max Load (lb/ft <sup>2</sup> )	Apparent EI x 10 <sup>6</sup> (lb-in <sup>2</sup> )
	50	100	150	200	250	500	1000	2000		
12	0.004	0.007	0.011	0.014	0.018	0.036	0.071	0.143	2378	0.31
18	0.017	0.033	0.050	0.066	0.083	0.166	0.332		1245	0.34
24	0.050	0.100	0.150	0.199	0.249	0.498			668	0.36
30	0.119	0.237	0.356	0.475	0.593				427	0.37
36	0.240	0.480							240	0.38
42	0.431								205	0.39

Properties Per Foot of Width	# of Bars	Load Bar Width	Bar Centers	Weight/sq ft
A = 1.79 in <sup>2</sup> I = 0.15 in <sup>4</sup> S = 0.30 in <sup>3</sup>	8	0.25"	1.5"	2.5

**1½" x 1½" x 1½"**  
**Square Grid**  
**1½" Thick**  
**68% Open**

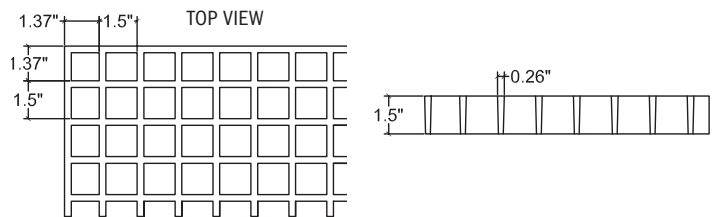
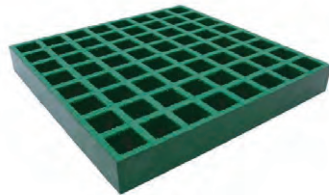

Span (inches)	CONCENTRATED LOAD in lb/ft of width								Max Load (lb/ft)	Apparent EI x 10 <sup>6</sup> (lb-in <sup>2</sup> )
	50	100	150	200	250	500	1000	2000		
12	0.002	0.005	0.007	0.009	0.011	0.023	0.045	0.090	2041	0.80
18	0.005	0.011	0.016	0.022	0.027	0.055	0.109		1360	1.11
24	0.012	0.023	0.035	0.046	0.058	0.115	0.230		1021	1.25
30	0.021	0.043	0.064	0.086	0.107	0.214			816	1.31
36	0.036	0.072	0.108	0.144	0.180	0.360			680	1.35
42	0.056	0.113	0.169	0.225	0.282	0.563			583	1.37
48	0.084	0.167	0.251	0.334	0.418				510	1.38
54	0.119	0.238	0.357	0.476	0.594				453	1.38

Span (inches)	UNIFORM LOAD in lb/ft <sup>2</sup>								Max Load (lb/ft <sup>2</sup> )	Apparent EI x 10 <sup>6</sup> (lb-in <sup>2</sup> )
	50	100	150	200	250	500	1000	2000		
12	0.001	0.003	0.004	0.006	0.007	0.014	0.028	0.057	4082	0.80
18	0.005	0.010	0.015	0.021	0.026	0.051	0.103		1813	1.11
24	0.014	0.029	0.043	0.058	0.072	0.144	0.288		1021	1.25
30	0.033	0.067	0.100	0.134	0.167	0.334			653	1.31
36	0.067	0.135	0.202	0.270	0.337				453	1.35
42	0.123	0.246	0.370	0.493	0.616				333	1.37
48	0.209	0.417	0.626						255	1.38
54	0.334	0.669							201	1.38

Properties Per Foot of Width	# of Bars	Load Bar Width	Bar Centers	Weight/sq ft
A = 2.73 in <sup>2</sup> I = 0.49 in <sup>4</sup> S = 0.65 in <sup>3</sup>	8	0.25"	1.5"	3.94

**2" x 2" x 2"**  
**Square Grid**  
**2" Thick**  
**71% Open**

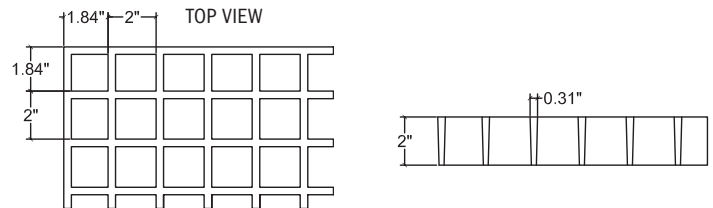

Span (inches)	CONCENTRATED LOAD in lb/ft of width								Max Load (lb/ft)	Apparent EI x 10 <sup>6</sup> (lb-in <sup>2</sup> )
	50	100	150	200	250	500	1000	2000		
12	0.001	0.002	0.003	0.004	0.005	0.010	0.020	0.040	4632	1.80
18	0.003	0.006	0.009	0.011	0.014	0.029	0.057	0.114	3088	2.13
24	0.006	0.012	0.018	0.024	0.030	0.060	0.120	0.240	2316	2.40
30	0.011	0.023	0.034	0.045	0.056	0.113	0.225		1853	2.50
36	0.019	0.038	0.057	0.076	0.095	0.191	0.381		1544	2.55
42	0.030	0.059	0.089	0.118	0.148	0.296	0.591		1323	2.61
48	0.043	0.087	0.130	0.174	0.217	0.435			1158	2.65
54	0.061	0.122	0.183	0.244	0.305	0.610			1029	2.69
60	0.083	0.166	0.249	0.332	0.415				926	2.71

Span (inches)	UNIFORM LOAD in lb/ft <sup>2</sup>								Max Load (lb/ft <sup>2</sup> )	Apparent EI x 10 <sup>6</sup> (lb-in <sup>2</sup> )
	50	100	150	200	250	500	1000	2000		
12	<0.001	0.001	0.002	0.003	0.003	0.006	0.013	0.025	9264	1.80
18	0.003	0.005	0.008	0.011	0.013	0.027	0.053	0.107	4117	2.13
24	0.008	0.015	0.023	0.030	0.038	0.075	0.150	0.300	2316	2.40
30	0.018	0.035	0.053	0.070	0.088	0.176	0.352		1482	2.50
36	0.036	0.071	0.107	0.143	0.179	0.357			1029	2.55
42	0.065	0.129	0.194	0.259	0.323	0.647			756	2.61
48	0.109	0.217	0.326	0.435	0.543				579	2.65
54	0.171	0.343	0.514	0.686					457	2.69
60	0.259	0.519							371	2.71

Properties Per Foot of Width	# of Bars	Load Bar Width	Bar Centers	Weight/sq ft
A = 3.12 in <sup>2</sup> I = 1.03 in <sup>4</sup> S = 1.03 in <sup>3</sup>	6	0.31" (5/16")	2"	4.51





**1" x 3/4" x 3/4"**  
**Square Grid**  
**1" Thick**  
**44% Open**

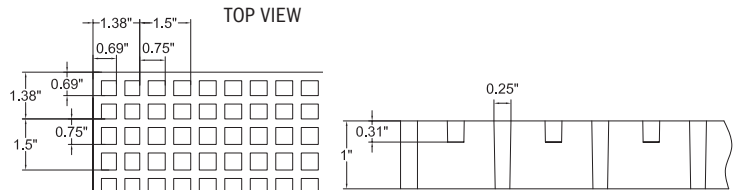
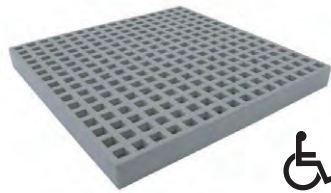

Span (inches)	CONCENTRATED LOAD in lb/ft of width								Max Load (lb/ft)	Apparent EI x 10 <sup>6</sup> (lb-in <sup>2</sup> )
	50	100	150	200	250	500	1000	2000		
12	0.003	0.006	0.012	0.031	0.045	0.059	0.089	0.120	1239	0.599
18	0.012	0.024	0.049	0.125	0.188	0.254	0.389		826	0.486
24	0.029	0.057	0.116	0.295	0.456	0.580			620	0.494
30	0.059	0.116	0.233	0.605					496	0.478
36	0.088	0.175	0.360						413	0.549
42	0.171	0.346							354	0.448
48	0.262	0.524							310	0.439
54	0.345	0.685							275	0.447

Span (inches)	UNIFORM LOAD in lb/ft <sup>2</sup>								Max Load (lb/ft <sup>2</sup> )	Apparent EI x 10 <sup>6</sup> (lb-in <sup>2</sup> )
	50	100	150	200	250	500	1000	2000		
12	0.002	0.005	0.007	0.009	0.011	0.023	0.046	0.091	2480	0.599
18	0.011	0.021	0.032	0.043	0.053	0.106	0.213	0.425	1425	0.486
24	0.033	0.066	0.098	0.131	0.164	0.328			825	0.494
30	0.077	0.154	0.230	0.307	0.384				536	0.478
36	0.168	0.336	0.504						310	0.549
42	0.323	0.645							250	0.448
48	0.537									0.439

Properties Per Foot of Width	# of Bars	Load Bar Width	Bar Centers	Weight/sq ft
A = 2.47 in <sup>2</sup> I = 0.16 in <sup>4</sup> S = 0.34 in <sup>3</sup>	8	0.25"	0.75"	4.06

**1 1/2" x 3/4" x 3/4"**  
**Square Grid**  
**1 1/2" Thick**  
**44% Open**

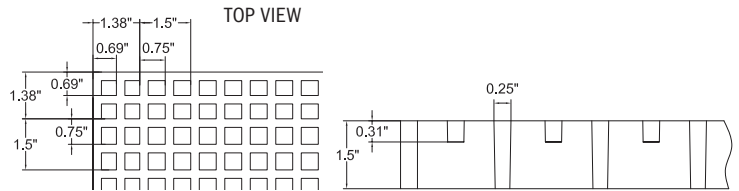
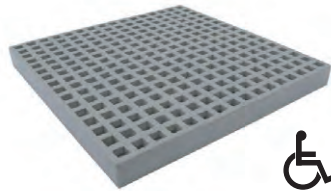

Span (inches)	CONCENTRATED LOAD in lb/ft of width								Max Load (lb/ft)	Apparent EI x 10 <sup>6</sup> (lb-in <sup>2</sup> )
	50	100	150	200	250	500	1000	2000		
12	0.002	0.003	0.005	0.006	0.008	0.016	0.032	0.063	3090	1.14
18	0.004	0.009	0.013	0.017	0.021	0.043	0.085	0.170	2060	1.43
24	0.009	0.018	0.026	0.035	0.044	0.088	0.176	0.352	1545	1.64
30	0.016	0.032	0.048	0.064	0.080	0.160	0.321	0.642	1236	1.75
36	0.027	0.053	0.080	0.106	0.133	0.266	0.532		1030	1.83
42	0.041	0.083	0.124	0.165	0.207	0.413			883	1.87
48	0.060	0.121	0.181	0.242	0.302	0.605			773	1.90
54	0.085	0.170	0.255	0.339	0.424				687	1.93
60	0.116	0.232	0.347	0.463	0.579				618	1.94

Span (inches)	UNIFORM LOAD in lb/ft <sup>2</sup>								Max Load (lb/ft <sup>2</sup> )	Apparent EI x 10 <sup>6</sup> (lb-in <sup>2</sup> )
	50	100	150	200	250	500	1000	2000		
12	<0.001	0.002	0.003	0.004	0.005	0.010	0.020	0.039	6180	1.14
18	0.004	0.008	0.012	0.016	0.020	0.040	0.080	0.159	2747	1.43
24	0.011	0.022	0.033	0.044	0.055	0.110	0.220		1545	1.64
30	0.025	0.050	0.075	0.100	0.125	0.251	0.502		989	1.75
36	0.050	0.100	0.149	0.199	0.249	0.498			687	1.83
42	0.090	0.181	0.271	0.362	0.452				505	1.87
48	0.151	0.302	0.454	0.605					386	1.90
54	0.239	0.477							305	1.93
60	0.362								247	1.94

Properties Per Foot of Width	# of Bars	Load Bar Width	Bar Centers	Weight/sq ft
A = 3.29 in <sup>2</sup> I = 0.74 in <sup>4</sup> S = 0.90 in <sup>3</sup>	8	0.25"	0.75"	4.75





**1 1/8" x 1 1/2" x 1 1/2"**  
**Square Grid**  
**1 1/8" Thick**  
**Covered**

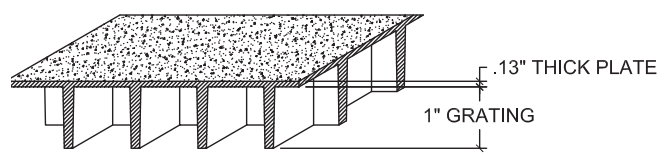
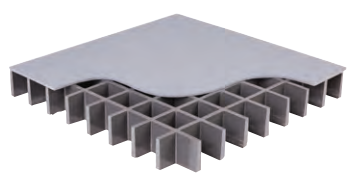

Span (inches)	CONCENTRATED LOAD in lb/ft of width								Max Load (lb/ft)	Apparent EI x 10 <sup>6</sup> (lb-in <sup>2</sup> )
	50	100	150	200	250	500	1000	2000		
12	0.006	0.011	0.017	0.023	0.029	0.057	0.114		1189	0.31
18	0.018	0.035	0.053	0.071	0.089	0.177			934	0.34
24	0.040	0.080	0.120	0.160	0.199	0.399			668	0.36
30	0.076	0.152	0.228	0.304	0.380				534	0.37
36	0.128	0.256	0.384	0.512	0.640				360	0.38

Span (inches)	UNIFORM LOAD in lb/ft <sup>2</sup>								Max Load (lb/ft <sup>2</sup> )	Apparent EI x 10 <sup>6</sup> (lb-in <sup>2</sup> )
	50	100	150	200	250	500	1000	2000		
12	0.004	0.007	0.011	0.014	0.018	0.036	0.071	0.143	2378	0.31
18	0.017	0.033	0.050	0.066	0.083	0.166	0.332		1245	0.34
24	0.050	0.100	0.150	0.199	0.249	0.498			668	0.36
30	0.119	0.237	0.356	0.475	0.593				427	0.37
36	0.240	0.480							240	0.38
42	0.431								205	0.39

Properties Per Foot of Width	# of Bars	Load Bar Width	Bar Centers	Weight/sq ft
A = 1.79 in <sup>2</sup> I = 0.15 in <sup>4</sup> S = 0.30 in <sup>3</sup>	8	0.25"	1.5"	2.73

**1 5/8" x 1 1/2" x 1 1/2"**  
**Square Grid**  
**1 5/8" Thick**  
**Covered**

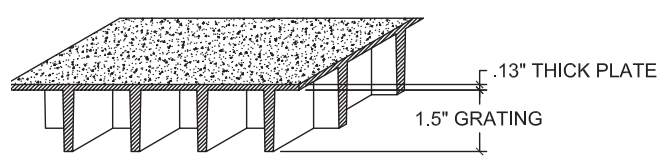
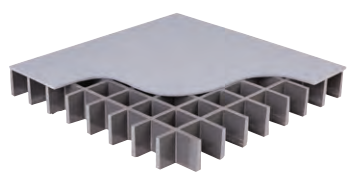

Span (inches)	CONCENTRATED LOAD in lb/ft of width								Max Load (lb/ft)	Apparent EI x 10 <sup>6</sup> (lb-in <sup>2</sup> )
	50	100	150	200	250	500	1000	2000		
12	0.002	0.005	0.007	0.009	0.011	0.023	0.045	0.090	2041	0.80
18	0.005	0.011	0.016	0.022	0.027	0.055	0.109		1360	1.11
24	0.012	0.023	0.035	0.046	0.058	0.115	0.230		1021	1.25
30	0.021	0.043	0.064	0.086	0.107	0.214			816	1.31
36	0.036	0.072	0.108	0.144	0.180	0.360			680	1.35
42	0.056	0.113	0.169	0.225	0.282	0.563			583	1.37
48	0.084	0.167	0.251	0.334	0.418				510	1.38
54	0.119	0.238	0.357	0.476	0.594				453	1.38

Span (inches)	UNIFORM LOAD in lb/ft <sup>2</sup>								Max Load (lb/ft <sup>2</sup> )	Apparent EI x 10 <sup>6</sup> (lb-in <sup>2</sup> )
	50	100	150	200	250	500	1000	2000		
12	0.001	0.003	0.004	0.006	0.007	0.014	0.028	0.057	4082	0.80
18	0.005	0.010	0.015	0.021	0.026	0.051	0.103		1813	1.11
24	0.014	0.029	0.043	0.058	0.072	0.144	0.288		1021	1.25
30	0.033	0.067	0.100	0.134	0.167	0.334			653	1.31
36	0.067	0.135	0.202	0.270	0.337				453	1.35
42	0.123	0.246	0.370	0.493	0.616				333	1.37
48	0.209	0.417	0.626						255	1.38
54	0.334	0.669							201	1.38

Properties Per Foot of Width	# of Bars	Load Bar Width	Bar Centers	Weight/sq ft
A = 2.73 in <sup>2</sup> I = 0.49 in <sup>4</sup> S = 0.65 in <sup>3</sup>	8	0.25"	1.5"	5.17



# PROGrid® High Load Capacity Molded Grating (HLC)



PROGrid® High Load Capacity (HLC) molded grating is high-strength, corrosion-resistant and low-maintenance – just like our PROGrid® molded grating products. Plus, it's engineered to carry higher loads than traditional grating. Our molded HLC grating is available in 4' x 6' panels with 1½" and 2" thicknesses and comes in GPFR, IFR and VFR resin systems in standard gray.

## Available Resin Systems

PROGrid® HLC molded grating is available in three resin systems, each providing different levels of corrosion protection. All three resin systems meet Class 1 Flame Spread Rating per ASTM E-84 test standards.

**GPFR:** A general-purpose orthophthalic polyester resin system that offers good corrosion resistance at an economical price.

**IFR:** A premium-grade isophthalic polyester resin system that provides excellent corrosion protection.

**VFR:** A vinyl ester resin system that provides the highest level of corrosion protection.

## APPLICATIONS



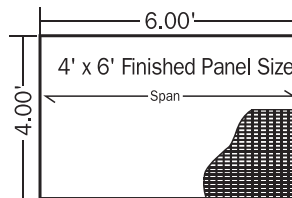

- Flooring, platforms and ramps
- Storage areas
- Assembly lines
- Long-span walkways
- Trench covers with vehicular traffic

## FEATURES

- High strength
- Corrosion resistant
- Low conductivity
- Fire retardant
- Low maintenance



NOTE: Load carrying bars are oriented to run in the 6' dimension of the panel. Panels furnished with closed bars all sides.

Allowable Spans for Vehicular Loads	Wheel Load (lb) (½ Axle Load + 30% impact)	Load Distribution		Allowable Span in Inches	
		Parallel to Axle <sup>1</sup>	Perpendicular to Axle <sup>2</sup>	1.5" Deep HLC Molded Grating	2" Deep HLC Molded Grating
 <b>AASHTO Standard Truck<sup>4</sup></b> 32,000 lb Axle Load – Dual Wheels (*formerly AASHTO H-20)	20,800	20" + 4"	8"	1'-2"	1'-5"
 <b>Automobile Traffic</b> 5,000 lb Vehicle – 1,500 lb Load 55% Drive Axle Load	2,220	8" + 4"	8"	2'-2"	2'-8"
 <b>5 Ton Capacity Forklift</b> 14,400 lb Vehicle – 24,400 lb Total Load 85% Drive Axle Load	13,480	11" + 4"	11"	1'1"	1'-5"
 <b>3 Ton Capacity Forklift</b> 9,800 lb Vehicle – 15,800 lb Total Load 85% Drive Axle Load	8,730	7" + 4"	7"	1'0"	1'-4"
 <b>1 Ton Capacity Forklift</b> 4,200 lb Vehicle – 6,200 lb Total Load 85% Drive Axle Load	3,425	4" + 4"	4"	1'7"	2'-1"

### NOTES: Allowable Spans for Vehicular Loads

1. Load is carried by the grating load bars immediately under wheel + four additional load bars adjacent to wheel.
2. Allowable Span is based on a 0.25" maximum deflection and a Factor of Safety of 3.0. Other criteria may be required by certain construction codes. Check code requirements to determine design criteria.

3. ALLOWABLE SPAN IS STRONGLY DEPENDENT ON WHEEL WIDTH AND VEHICLE WEIGHT/LOAD CAPACITY. If your application varies from the values given on this table, contact us for application assistance.
4. Load based on the AASHTO Standard Truck Load as defined in AASHTO LRFD Bridge Design Specifications, 2nd Ed. This does not imply that the allowable span meets the deflection requirements of this specification.





# PROGrid® High Load Capacity Molded Grating Load and Deflection Data

## CONCENTRATED LOAD

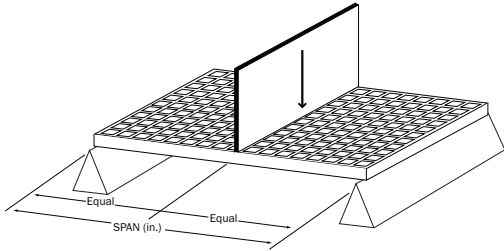

## UNIFORM LOAD

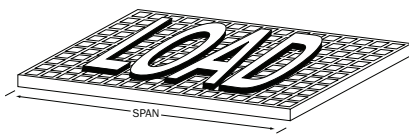

1. The following tables were developed in accordance with the test method developed by the Fiberglass Grating Manufacturers Council (FGMC) of the American Composites Manufacturers Association (ACMA) for the Fiberglass Grating Standard.
2. The designer should not exceed MAXIMUM RECOMMENDED load at any time. MAXIMUM LOAD represents a 4:1 factor of safety on ULTIMATE CAPACITY. ULTIMATE CAPACITY represents MAX LOAD observed at initial fracture.
3. Walking loads for maintenance traffic are typically a live load of 50 PSF. Deflections for worker comfort are typically limited to 0.375" (<sup>3</sup>/<sub>8</sub>" ) or SPAN divided by 120 under full live load. For a firmer feel under full live load or a line load 250 lb/ft of width, limit deflections to 0.25" (<sup>1</sup>/<sub>4</sub>" ) or SPAN divided by 200.
4. The loads represented are for STATIC LOAD CONDITIONS at ambient temperature. Deflections for impact loads or dynamic loads will MULTIPLY the deflections shown by 2. Long term loads will result in added deflection due to creep in the material and will require higher factors of safety to ensure acceptable performance.
5. Deflections are limited to 0.5" (<sup>1</sup>/<sub>2</sub>" ) as recommended by the Fiberglass Grating Manufacturers Council of the American Composites Manufacturers Association.

**1½" x 1" x 2" HLC  
Rectangular Grid  
1½" Thick  
48% Open**

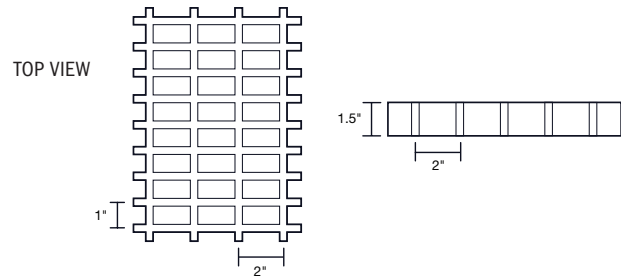
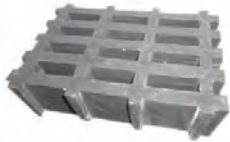

Span (inches)	CONCENTRATED LOAD in lb/ft of width							Max Load (lb/ft)
	200	500	1000	2000	3000	4000	5000	
18	<0.01	0.02	0.04	0.07	0.11	0.15	0.19	28,047
24	0.02	0.04	0.09	0.17	0.26	0.34	0.44	20,430
36	0.06	0.14	0.28					13,620
42	0.09	0.22	0.44					11,619

Span (inches)	UNIFORM LOAD in lb/ft <sup>2</sup>						Max Load (lb/ft <sup>2</sup> )
	200	400	500	600	700	800	
18	<0.01	0.01	0.02	0.02	0.02	0.03	36,000
24	0.02	0.04	0.05	0.06	0.08	0.09	20,390
36	0.10	0.21	0.26	0.31	0.37	0.42	8,814
42	0.19	0.39	0.48				6,550

Properties Per Foot of Width	# of Bars	Load Bar Width	Bar Centers	Weight/sq ft
A=7.2 in <sup>2</sup> I=1.35 in <sup>4</sup> S=1.75	12	T-.43 / B-.35	1"	6.21

**2" x 1" x 2" HLC  
Rectangular Grid  
2" Thick  
48% Open**

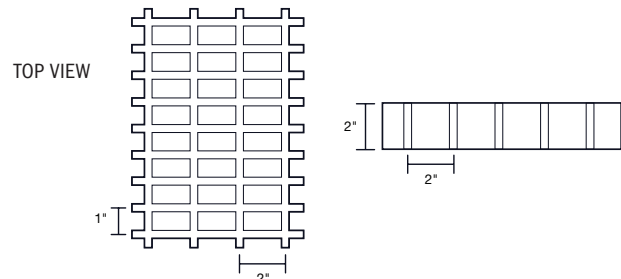

Span (inches)	CONCENTRATED LOAD in lb/ft of width							Max Load (lb/ft)
	200	500	1000	2000	3000	4000	5000	
18	<0.01	0.01	0.03	0.05	0.07	0.10	0.13"	32,651
24	0.02	0.03	0.06	0.11	0.17	0.22	0.27	27,245
36	0.04	0.09	0.17	0.34	0.51			18,130
42	0.05	0.13	0.26					15,525

Span (inches)	UNIFORM LOAD in lb/ft <sup>2</sup>						Max Load (lb/ft <sup>2</sup> )
	200	400	500	600	700	800	
18	<0.01	0.01	0.01	0.01	0.01	0.01	43,494
24	0.01	0.02	0.03	0.04	0.04	0.05	27,195
36	0.06	0.12	0.15	0.18	0.21	0.24	8,795
42	0.11	0.22	0.28	0.33	0.39	0.44	8,795

Properties Per Foot of Width	# of Bars	Load Bar Width	Bar Centers	Weight/sq ft
A=7.2 in <sup>2</sup> I=1.35 in <sup>4</sup> S=1.75	12	T-.47 / B-.35	1"	8.4



## PROGrate® Pultruded Grating

PROGrate® pultruded grating supports heavier loads and longer spans than comparably sized molded grating. It's ideal for demanding applications ranging from ADA-compliant walkways to heavy-duty vehicular traffic.

### **Strong, Lightweight and Corrosion-Resistant**

PROGrate® pultruded grating has the strength of steel, but it won't corrode like steel can.

### **Safer Walking Surface**

A quartz grit anti-slip epoxy coating enhances traction.

### **Support and Stability**

Cross-rods and bearing bars lock mechanically for maximum unidirectional strength.

### **Easy Fabrication**

Panels are lightweight, easy to transport, and can be cut and fabricated using standard hand tools.

### **Extended Life**

The coated resin surface increases resistance to chemical corrosion and continuous UV exposure.

### **Stress Resistance**

Continuous glass rovings resist tension, compression and bending while providing longitudinal strength. Continuous glass mat increases transverse strength and resistance to impact.



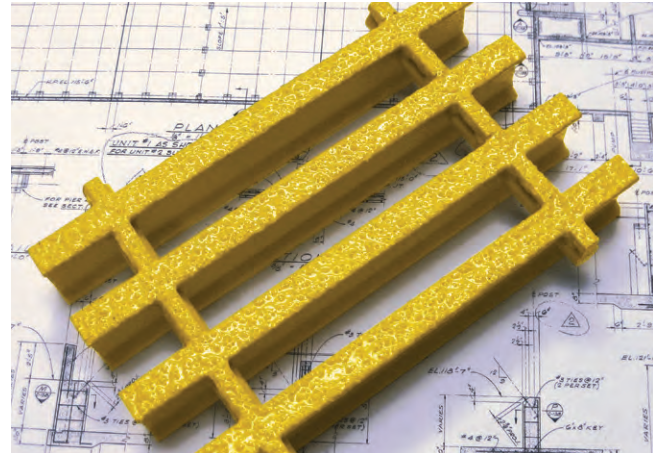
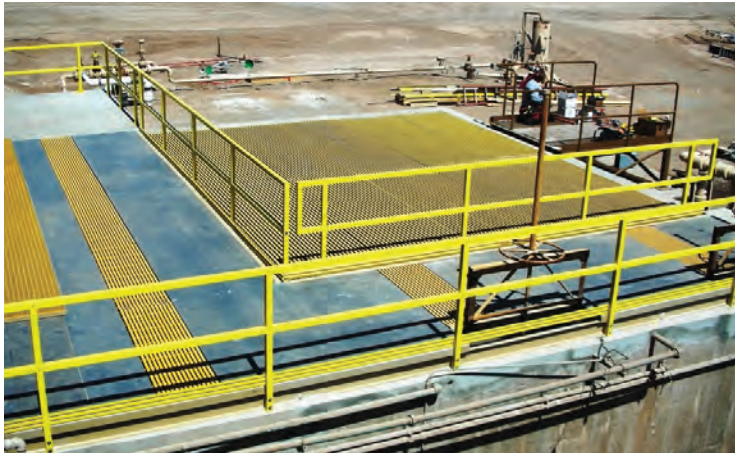

### Available Resin Systems

PROGrate® pultruded grating is available in two resin systems, each providing different levels of corrosion protection. Both resin systems meet Class 1 Flame Spread Rating per ASTM E-84 test standards.

**IFR:** A premium-grade isophthalic polyester resin system that provides excellent corrosion protection. Standard colors: Yellow and Gray.

**VFR:** A vinylester resin system that provides the highest level of corrosion protection. Standard colors: Yellow and Gray.

### APPLICATIONS

- Floor systems
- Walkways
- Work platforms
- Stairs
- Ramps
- Trench covers
- Catwalks

UV Inhibitor Fire Retardant Polyester or Vinylester Resin

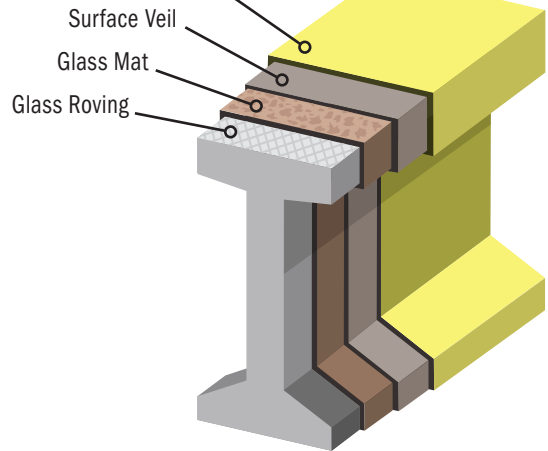

### Standard Dimensions

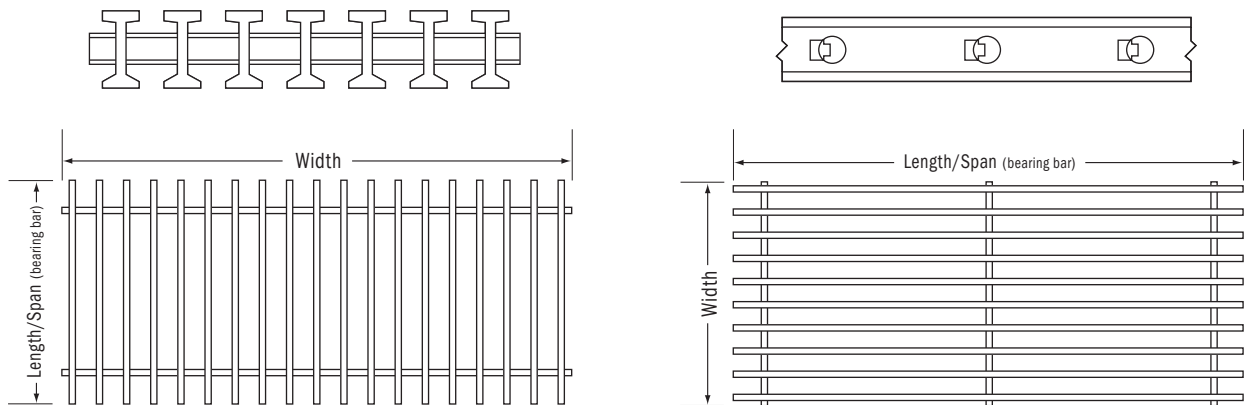

### Available Panel Sizes\*

3' wide x 20' long	4' wide x 20' long
3' wide x 24' long	4' wide x 24' long

\*Note: Not all panel sizes are stocked in every resin series and color. Check website for availability.

# PROGrate® Pultruded Grating Load and Deflection Data

## CONCENTRATED LOAD

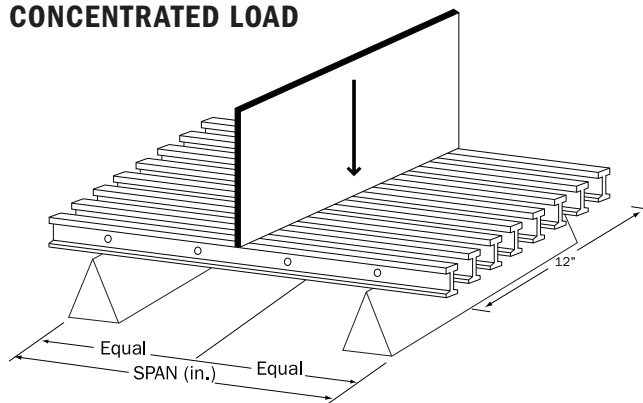

## UNIFORM LOAD

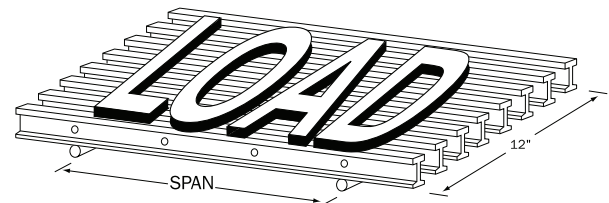

1. The following tables were developed in accordance with the test method developed by the Fiberglass Grating Manufacturers Council (FGMC) of the American Composites Manufacturers Association (ACMA) for the Fiberglass Grating Standard.
2. The designer should not exceed MAXIMUM RECOMMENDED load at any time. ULTIMATE CAPACITY represents MAX LOAD observed at initial fracture.
3. Walking loads for maintenance traffic are typically a live load of 50 PSF. Deflections for worker comfort are typically limited to 0.375" (3/8") or SPAN divided by 120 under full live load. For a firmer feel under full live load or a line load 250 lb/ft of width, limit deflections to 0.25" (1/4") or SPAN divided by 200.
4. The loads represented are for STATIC LOAD CONDITIONS at ambient temperature. Deflections for impact loads or dynamic loads will MULTIPLY the deflections shown by 2. Long term loads will result in added deflection due to creep in the material and will require higher factors of safety to ensure acceptable performance.
5. Deflections are limited to 0.5" (1/2") as recommended by the Fiberglass Grating Manufacturers Council of the American Composites Manufacturers Association.

**T 20-50**  
**T Bearing Bar**  
**2" Thick**  
**50% Open**

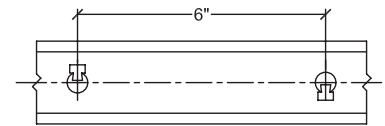
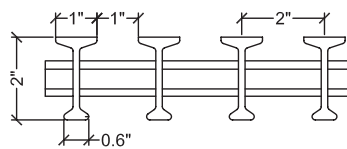
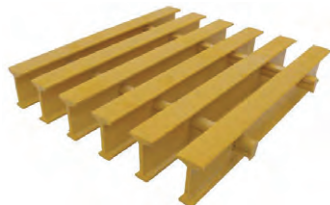

Span (inches)	CONCENTRATED LOAD in lb/ft of width								Max Load (lb/ft)	Apparent EI x 10 <sup>6</sup> (lb-in <sup>2</sup> )
	50	100	150	200	250	500	1000	2000		
12	0.001	0.002	0.003	0.004	0.005	0.010	0.020	0.040	13302	1.80
18	0.001	0.003	0.004	0.006	0.007	0.015	0.029	0.059	8868	4.15
24	0.002	0.005	0.007	0.009	0.012	0.023	0.047	0.093	6651	6.17
30	0.004	0.008	0.011	0.015	0.019	0.038	0.077	0.153	5321	7.35
36	0.006	0.012	0.018	0.024	0.031	0.061	0.122	0.245	4434	7.95
42	0.009	0.019	0.028	0.037	0.046	0.093	0.186	0.372	3801	8.31
48	0.013	0.027	0.040	0.054	0.067	0.135	0.269	0.539	3326	8.55
54	0.019	0.038	0.057	0.076	0.095	0.190	0.379		2956	8.65
60	0.026	0.051	0.077	0.103	0.129	0.257	0.514		2660	8.75
66	0.034	0.068	0.102	0.136	0.171	0.341	0.682		2419	8.78
72	0.044	0.088	0.133	0.177	0.221	0.442			2217	8.80

Span (inches)	UNIFORM LOAD in lb/ft <sup>2</sup>								Max Load (lb/ft <sup>2</sup> )	Apparent EI x 10 <sup>6</sup> (lb-in <sup>2</sup> )
	50	100	150	200	250	500	1000	2000		
12	0.001	0.001	0.002	0.002	0.003	0.006	0.012	0.025	23936	1.80
18	0.001	0.003	0.004	0.005	0.007	0.014	0.027	0.055	8624	4.15
24	0.003	0.006	0.009	0.012	0.015	0.029	0.058	0.117	6468	6.17
30	0.006	0.012	0.180	0.024	0.030	0.060	0.120	0.239	4242	7.35
36	0.011	0.023	0.034	0.046	0.057	0.115	0.229	0.458	2946	7.95
42	0.020	0.041	0.061	0.081	0.102	0.203	0.407		2153	8.31
48	0.034	0.067	0.101	0.135	0.168	0.337	0.674		1672	8.55
54	0.053	0.107	0.160	0.213	0.267	0.533			1310	8.65
60	0.080	0.161	0.241	0.321	0.402				1062	8.75
66	0.117	0.234	0.352	0.469	0.586				881	8.78
72	0.166	0.331	0.497	0.663					740	8.80

Properties Per Foot of Width	# of Bars	Load Bar Depth	Bar Centers	Weight/sq ft
A = 3.23 in <sup>2</sup> I = 1.58 in <sup>4</sup> S <sub>T</sub> = 1.98 in <sup>3</sup> S <sub>B</sub> = 1.32 in <sup>3</sup>	6	2"	2"	3.43





**I 10-60**  
**I Bearing Bar**  
**1" Thick**  
**60% Open**

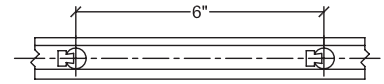
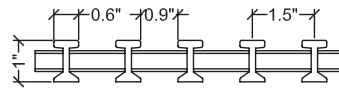
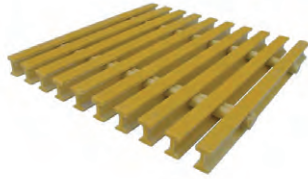

Span (inches)	CONCENTRATED LOAD in lb/ft of width								Max Load (lb/ft)	Apparent EI x 10 <sup>6</sup> (lb-in <sup>2</sup> )
	50	100	150	200	250	500	1000	2000		
12	0.002	0.003	0.005	0.007	0.008	0.016	0.033	0.065	5755	1.10
18	0.004	0.009	0.013	0.018	0.022	0.044	0.088	0.176	3850	1.38
24	0.009	0.019	0.028	0.037	0.047	0.094	0.187	0.374	2888	1.54
30	0.017	0.035	0.052	0.069	0.086	0.173	0.345	0.690	2310	1.63
36	0.029	0.059	0.088	0.117	0.146	0.293	0.586		1925	1.66
42	0.046	0.092	0.138	0.184	0.230	0.459			1650	1.68
48	0.068	0.136	0.203	0.271	0.339	0.678			1444	1.70
54	0.095	0.191	0.286	0.381	0.477				1283	1.72
60	0.129	0.259	0.388	0.517	0.647				1155	1.74
66	0.171	0.342	0.513	0.685					1050	1.75
72	0.221	0.442	0.663						962	1.76

Span (inches)	UNIFORM LOAD in lb/ft <sup>2</sup>								Max Load (lb/ft <sup>2</sup> )	Apparent EI x 10 <sup>6</sup> (lb-in <sup>2</sup> )
	50	100	150	200	250	500	1000	2000		
12	0.001	0.002	0.003	0.004	0.005	0.010	0.020	0.041	7944	1.10
18	0.004	0.008	0.012	0.017	0.021	0.041	0.083	0.165	5296	1.38
24	0.012	0.023	0.035	0.047	0.058	0.117	0.234	0.468	2935	1.54
30	0.027	0.054	0.081	0.108	0.135	0.270	0.539		1845	1.63
36	0.055	0.110	0.165	0.220	0.274	0.549			1281	1.66
42	0.100	0.201	0.301	0.402	0.502				943	1.68
48	0.169	0.339	0.508	0.678					721	1.70
54	0.268	0.536							571	1.72
60	0.404								514	1.74

Properties Per Foot of Width	# of Bars	Load Bar Depth	Bar Centers	Weight/sq ft
A = 2.44 in <sup>2</sup> I = 0.31 in <sup>4</sup> S = 0.62 in <sup>3</sup>	8	1"	1.5"	2.47

**I 10-83**  
**I Bearing Bar**  
**1" Thick**  
**83% Open**

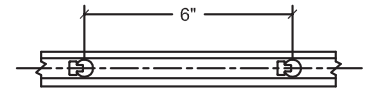
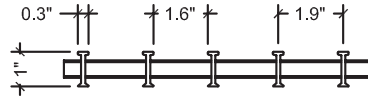
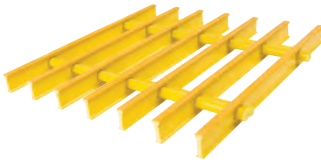

Span (inches)	CONCENTRATED LOAD in lb/ft of width						Max Load (lb/ft)	Apparent EI x 10 <sup>6</sup> (lb-in <sup>2</sup> )
	50	100	200	500	750	1000		
12	0.0065	0.013	0.026	0.065	0.098	0.130	1812	2.31
18	0.013	0.026	0.052	0.130	0.195	0.260	1208	3.89
24	0.029	0.058	0.116	0.290	0.435		906	4.14
30	0.056	0.112	0.224	0.560			725	4.19
36	0.099	0.198	0.396				604	4.09
42	0.155	0.310	0.620				518	4.15
48	0.225	0.450	0.900				453	4.27
54	0.317	0.634					403	4.31
60	0.408	0.816					362	4.60

Span (inches)	UNIFORM LOAD in lb/ft <sup>2</sup>						Max Load (lb/ft <sup>2</sup> )	Apparent EI x 10 <sup>6</sup> (lb-in <sup>2</sup> )
	50	100	200	500	750	1000		
12	0.003	0.006	0.010	0.013	0.016	0.032	3841	2.31
18	0.011	0.022	0.033	0.044	0.055	0.110	2560	3.89
24	0.031	0.061	0.092	0.123	0.153	0.307	1920	4.14
30	0.056	0.111	0.167	0.222	0.278	0.555	1536	4.19
36	0.163	0.326	0.488	0.651	0.814		1280	4.09
42	0.303	0.606	0.909				1097	4.15
48	0.519						960	4.27
54	0.867						853	4.31
60	1.509						768	4.60

Properties Per Foot of Width	# of Bars	Load Bar Depth	Bar Centers	Weight/sq ft
A = 1.19 in <sup>2</sup> I = 0.12 in <sup>4</sup> S = 0.24 in <sup>3</sup>	6	1	1.9"	2

**I 15-60**  
**I Bearing Bar**  
**1½" Thick**  
**60% Open**

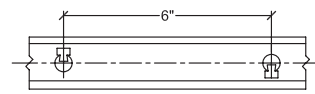
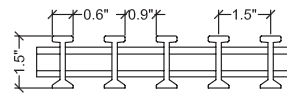
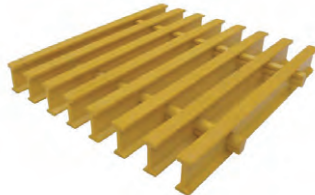

Span (inches)	CONCENTRATED LOAD in lb/ft of width								Max Load (lb/ft)	Apparent EI x 10 <sup>6</sup> (lb-in <sup>2</sup> )
	50	100	150	200	250	500	1000	2000		
12	0.001	0.002	0.003	0.004	0.005	0.009	0.018	0.036	8958	1.99
18	0.002	0.004	0.006	0.008	0.009	0.019	0.038	0.075	5972	3.23
24	0.004	0.007	0.011	0.015	0.018	0.037	0.074	0.147	4479	3.91
30	0.007	0.013	0.020	0.027	0.033	0.066	0.133	0.265	3853	4.24
36	0.011	0.022	0.033	0.044	0.055	0.110	0.220	0.441	2986	4.41
42	0.017	0.035	0.052	0.069	0.086	0.173	0.345	0.691	2559	4.47
48	0.026	0.051	0.077	0.102	0.128	0.255	0.511		2240	4.51
54	0.036	0.073	0.109	0.145	0.181	0.363			1991	4.52
60	0.050	0.099	0.149	0.198	0.248	0.496			1792	4.54
66	0.066	0.132	0.197	0.263	0.329	0.658			1629	4.55
72	0.085	0.171	0.256	0.341	0.427				1493	4.56

Span (inches)	UNIFORM LOAD in lb/ft <sup>2</sup>								Max Load (lb/ft <sup>2</sup> )	Apparent EI x 10 <sup>6</sup> (lb-in <sup>2</sup> )
	50	100	150	200	250	500	1000	2000		
12	0.001	0.001	0.002	0.002	0.003	0.006	0.011	0.023	10524	1.99
18	0.002	0.004	0.005	0.007	0.009	0.018	0.035	0.070	7016	3.23
24	0.005	0.009	0.014	0.018	0.023	0.046	0.092	0.184	4585	3.91
30	0.010	0.021	0.031	0.041	0.052	0.104	0.207	0.415	2831	4.24
36	0.021	0.041	0.062	0.083	0.103	0.207	0.413		2006	4.41
42	0.038	0.076	0.113	0.151	0.189	0.378			1454	4.47
48	0.064	0.128	0.192	0.255	0.319	0.639			1117	4.51
54	0.102	0.204	0.306	0.408	0.510				885	4.52
60	0.155	0.310	0.465	0.620					717	4.54
66	0.226	0.453	0.679						592	4.55
72	0.320	0.640							498	4.56

Properties Per Foot of Width	# of Bars	Load Bar Depth	Bar Centers	Weight/sq ft
A = 3.11 in <sup>2</sup> I = 0.88 in <sup>4</sup> S = 1.17 in <sup>3</sup>	8	1.5"	1.5"	2.97

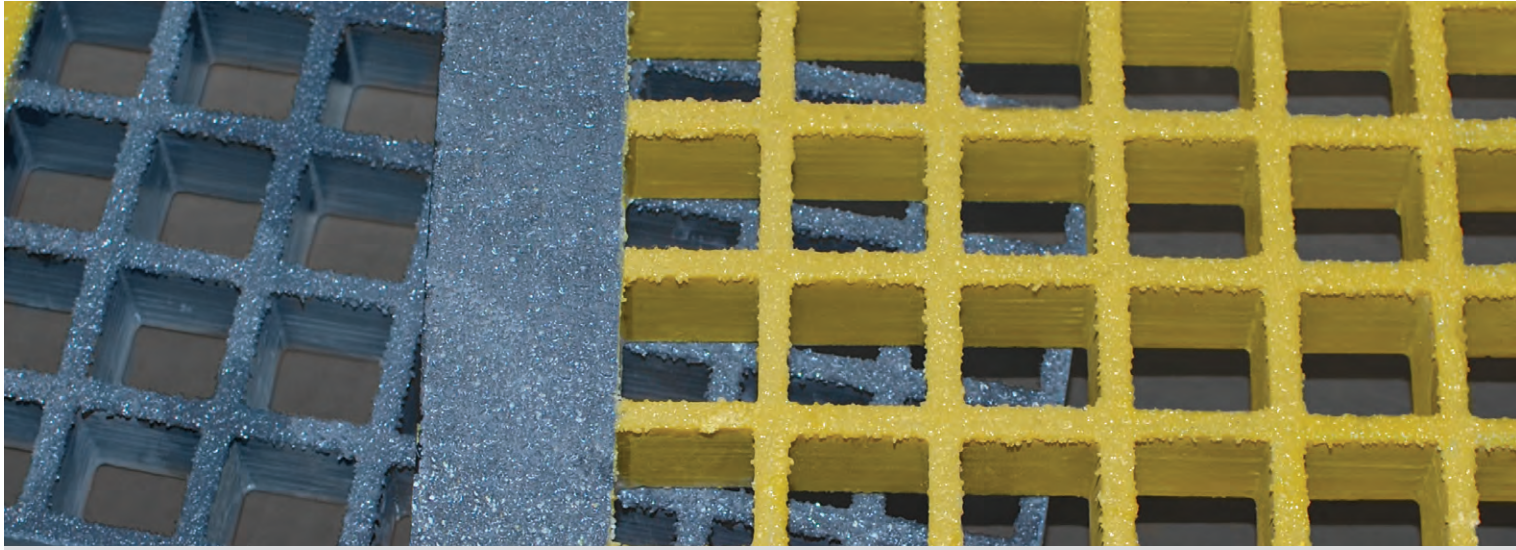

## PROGrid® Molded & PROGrate® Pultruded Stair Treads & Stair Tread Covers

### Stair Treads

Our stair tread panels allow you to cut your own stair treads quickly and inexpensively for less waste and less cost. We stock PROGrid® molded stair treads in several sizes and configurations. Custom-fabricated sizes are available upon request.

We can also supply PROGrate® pultruded stair tread in stock sizes or made to order. These maintenance-free treads are engineered for strength, durability and corrosion resistance. Features include a non-skid surface and square tube nosing for high visibility. Our design is easy to fabricate and install on-site with basic tools.

### Stair Tread Covers

FRP stair tread covers are a cost-effective option to improve stairway safety for your workers. All of our stair treads are made with corrosion-resistant, fire-retardant resin and have an anti-skid top surface.

### Grating Fasteners

All grating must be fastened in place. We offer a variety of clips to complete your installation (see page 20).

### Chemical Compatibility

See page 51 for a detailed table of chemical compatibility based on resin manufacturers' data, including maximum allowable concentrations and temperatures.

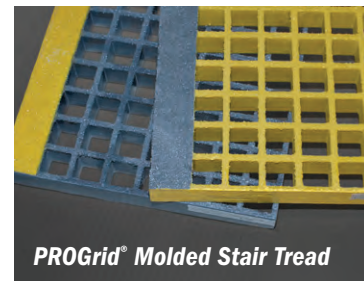

*PROGrid® Molded Stair Tread*



*PROGrate® Pultruded Stair Tread*

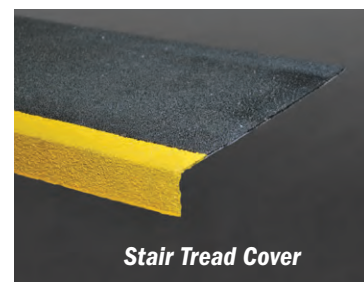

*Stair Tread Cover*



# PROGrid®/PROGrate® Stair Treads and Covers

## Load and Deflection Data

### PROGrid® Molded Grating Stair Treads

1½" x 1½" x 6"

1½" deep w/1½" x 6" mesh size			
Span (inches)	250 lb	500 lb	Max lb
18	0.04	0.07	7887
24	0.06	0.12	6084
30	0.12	0.25	4907
36	0.23	0.51	3302
42	0.25	0.56	3480

1½" x 1½" x 1½"

1½" deep w/1½" x 1½" mesh size			
Span (inches)	250 lb	500 lb	Max lb
18	0.03	0.06	9644
24	0.07	0.13	6848
30	0.09	0.18	5555
36	0.15	0.31	4666
42	0.23	0.48	4063

### PROGrate® Pultruded Grating Stair Treads

I 15-60

1½" deep I-beam w/60% open area			
Span (inches)	250 lb	500 lb	Max lb
18	0.02	0.03	12187
24	0.03	0.05	11424
30	0.04	0.07	10256
36	0.06	0.11	8157
42	0.08	0.16	7010

T 20-50

2" deep T-beam w/50% open area			
Span (inches)	250 lb	500 lb	Max lb
18	0.01	0.03	13230
24	0.03	0.05	11962
30	0.03	0.05	12490
36	0.04	0.07	11297
42	0.05	0.09	11412

Deflection values are based on concentrated loads of 250 lb and 500 lb applied at the center of span. Span and deflection values are in inches. Max lb represents maximum experimental failure load.

1½" x 1½" x 6"  
PROGrid® Molded Stair Tread  
24" x 144" Panel, 65% Open

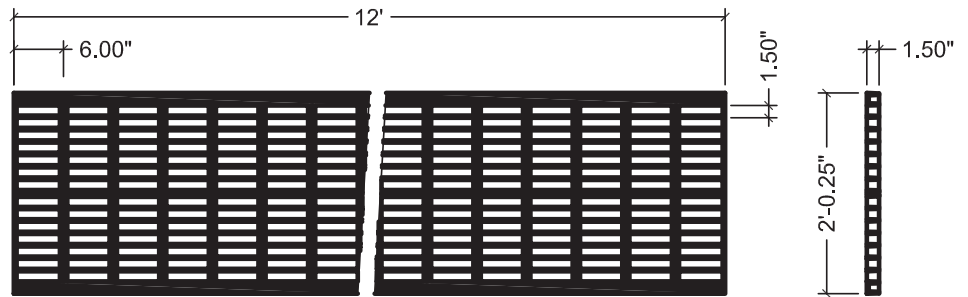

1½" x 1½" x 1½"  
PROGrid® Molded Stair Tread  
12" x 144" Panel, 68% Open

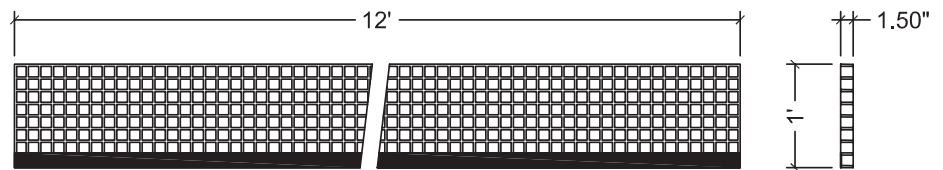
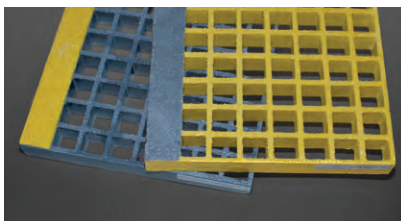

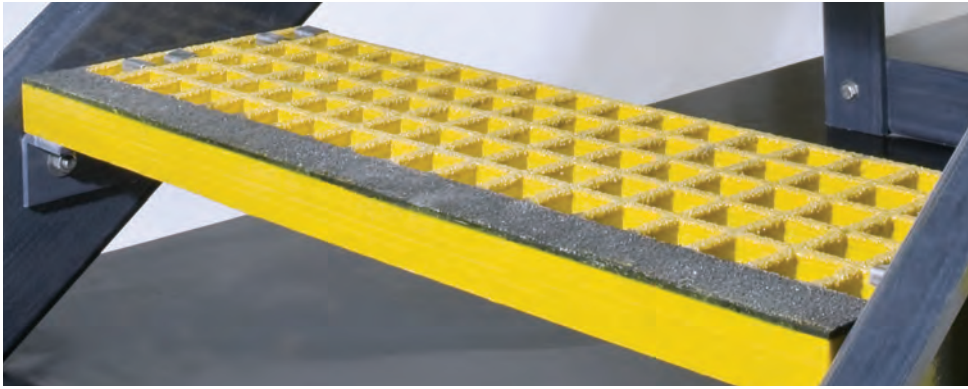

**1½" x 1½" x 1½"**  
**PROGrid® Molded Stair Tread**  
 25" x 144" Panel, 68% Open

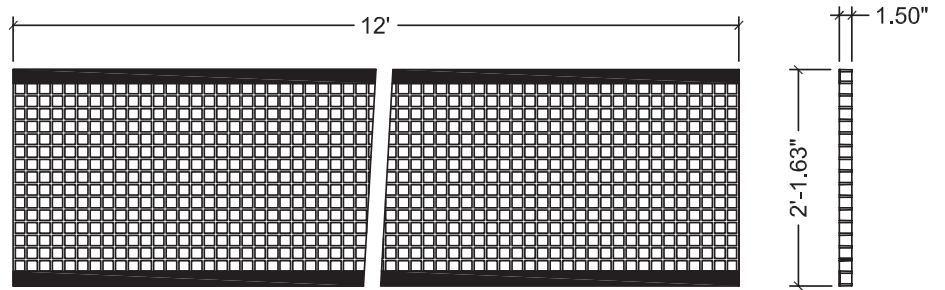
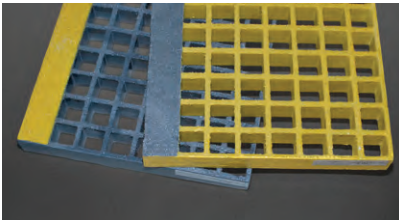

**I 15-60**  
**I Bearing Bar**  
**PROGrate® Pultruded Stair Tread**  
 12" x 144" Panel, 60% Open

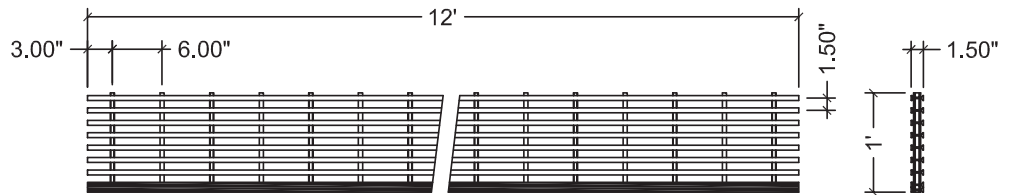
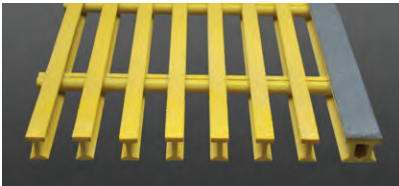

**T 20-50**  
**T Bearing Bar**  
**PROGrate® Pultruded Stair Tread**  
 12" x 144" Panel, 50% Open

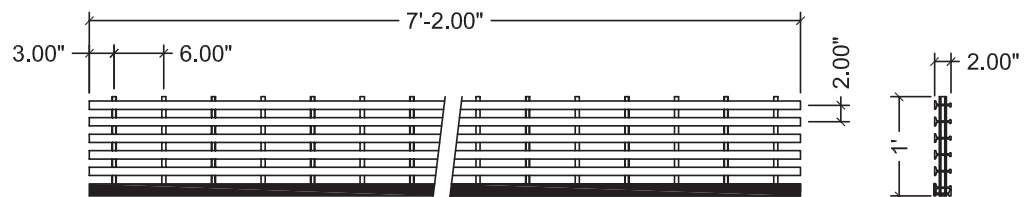



## Stair Tread Cover

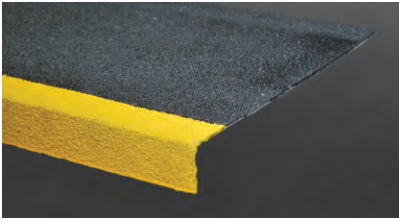

### Cover Placement for Wood and Concrete Treads

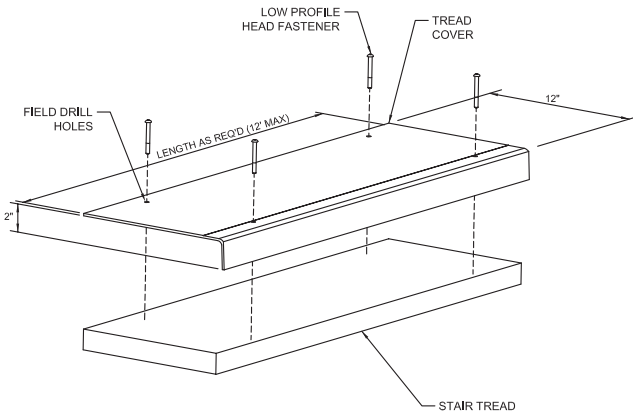

### Cover Placement for Stair Tread Grating

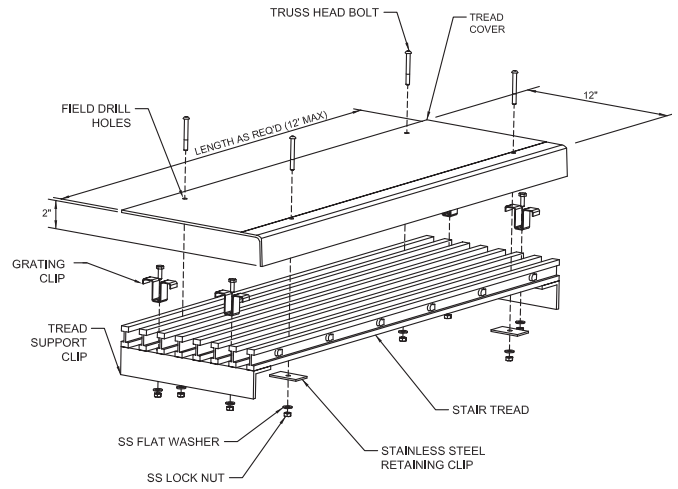

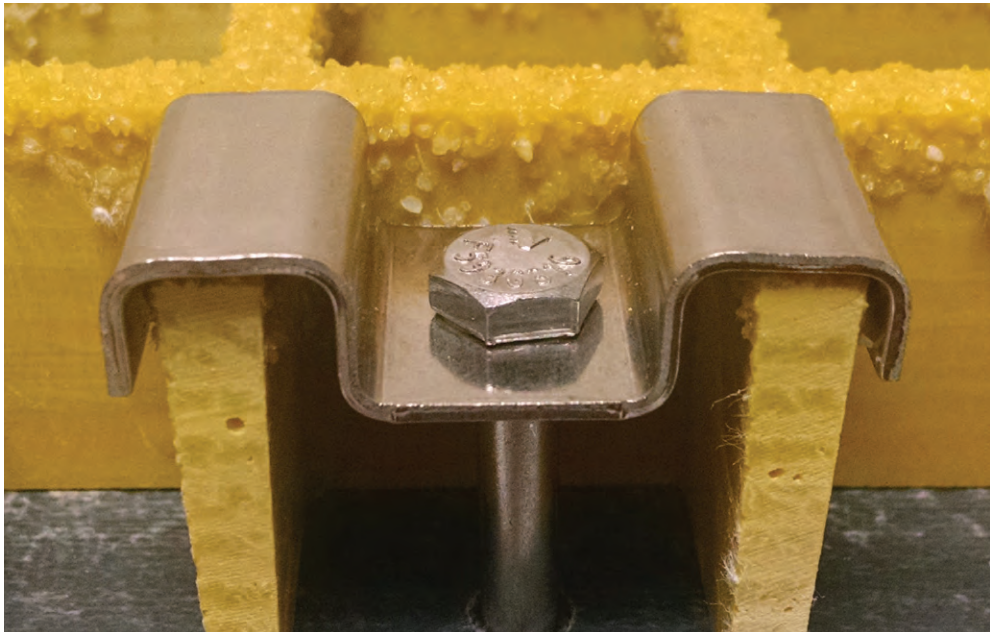
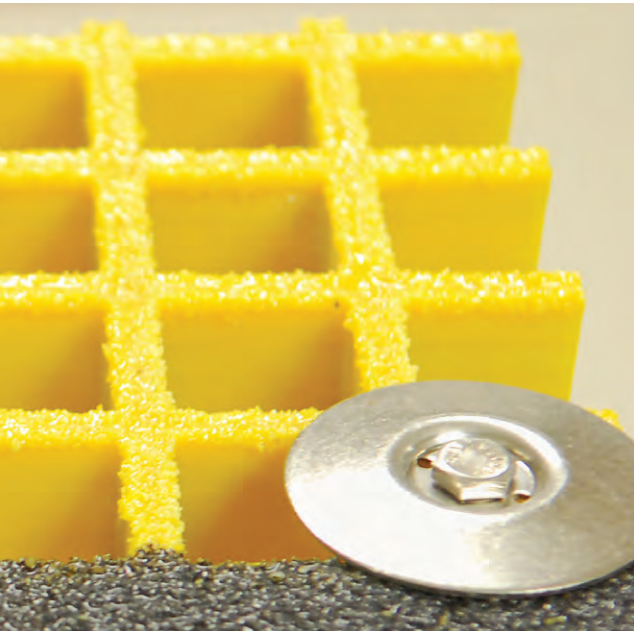

## Fasteners

# FASTEN YOUR GRATING FOR A SECURE FIT

We offer several types of clips to secure our grating products. Normally, the maximum distance between clips should be no more than 4'. All metal clips are made of SS316 stainless steel with a thickness of 0.06". See pages 48-50 to find the clips that fit your application.

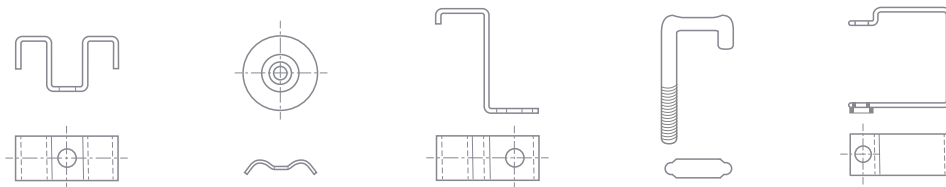



# Fasteners for Molded and Pultruded Grating

## M Clip (Saddle Clip)

M clips are used to secure molded or pultruded grating panels to a support using two adjacent grating bars for a secure fit.

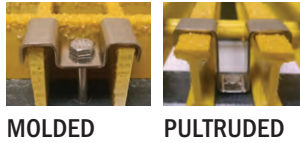

## W Clip (Washer Clip)

W clips are made specifically for plate or grating with plate on top. The length of the bolt should correspond with the height of the panel.

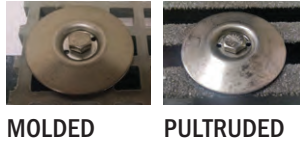

## L Clip (J Clip)

L clips are used to fasten molded or pultruded grating to a support bar for moderate loads.

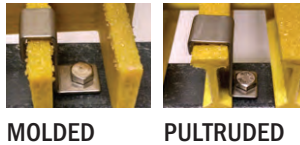

# Additional Fasteners

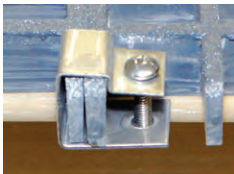

## C Clip (End Panel Clip)

C clips are used to join two ends of molded grating together. Clips should be placed every 2'-3' to meet industry requirements.



## G Clips

G clips are designed to attach grating to any structural member flange, 0.75" or smaller in thickness, with no drilling required.



## J Bolts

J bolts are used to secure grating to a support bar.

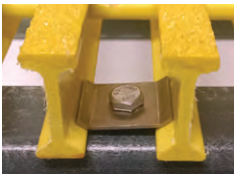

## T Clips

T clips are used to fasten pultruded grating to a support frame.

# Fastener Location Examples

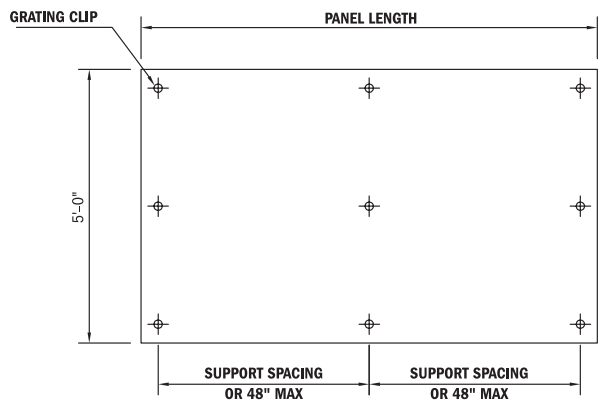
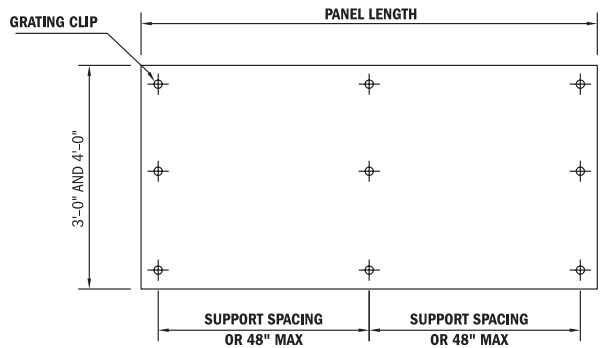
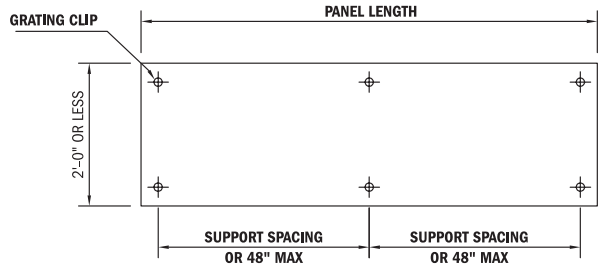

Provide a minimum of 1½" bearing surface per support.

Standard clip spacing is three clips per support per grating panel.

Standard clip spacing for 2'-0" or less in panel width is two clips per support per grating panel.

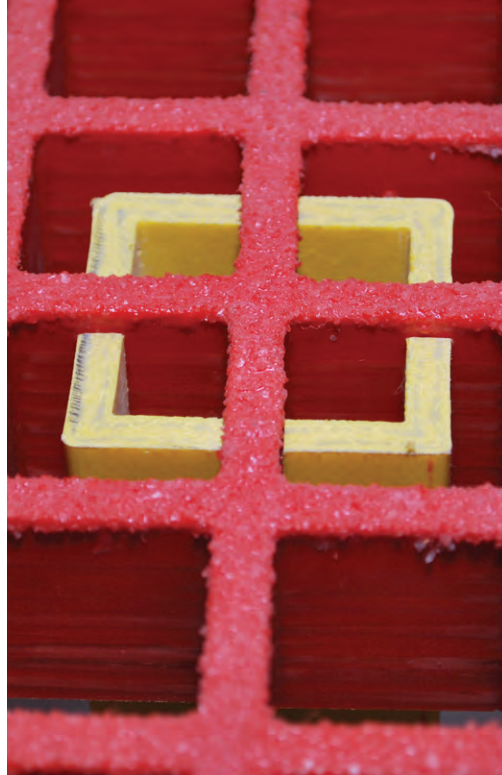

## Grating Pedestals



We offer several pedestals for applications requiring elevated grating floor systems. Contact us for sizes and availability.



**Adjustable Pedestal**

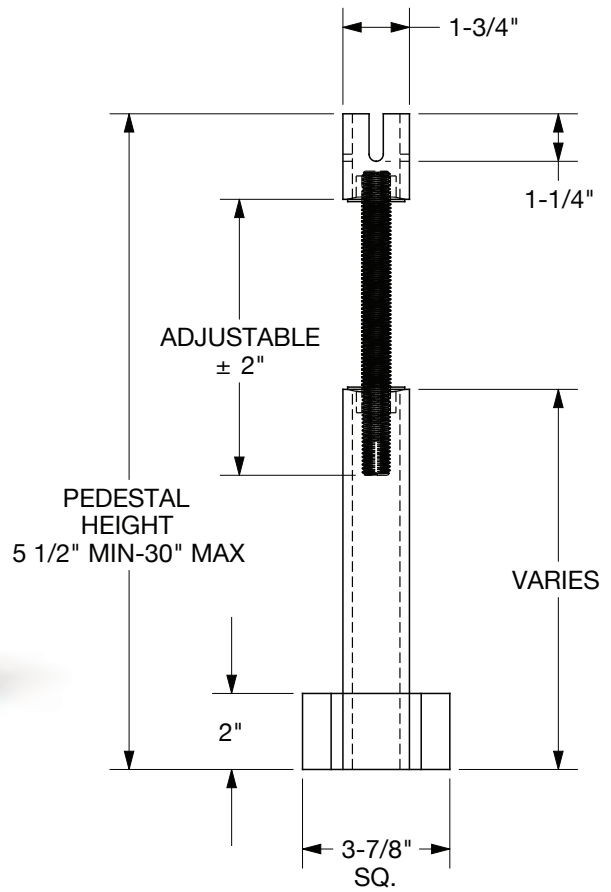

**Fixed Pedestal**

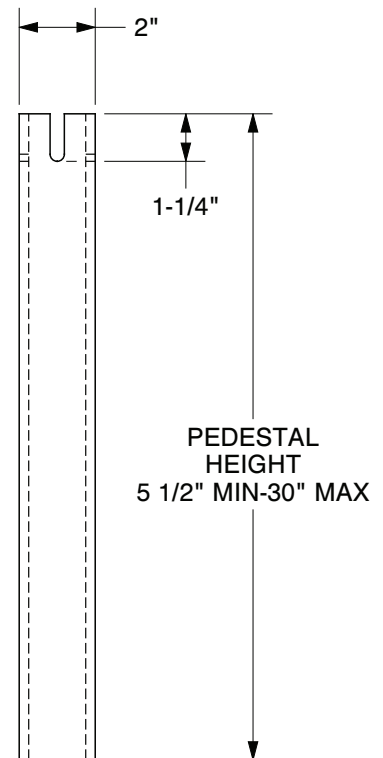
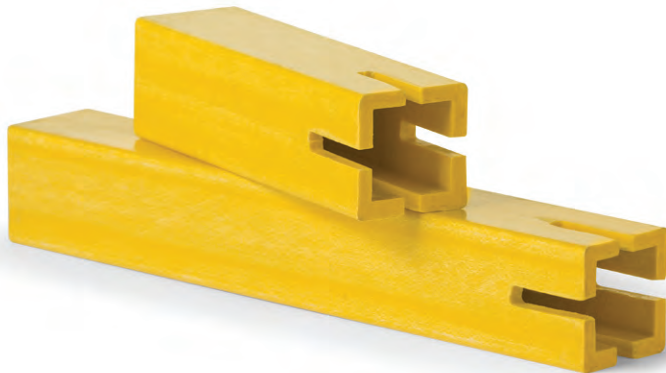

# PROForms® Embedment Angle

PROForms® FRP embedment angle is manufactured with premium-grade vinylester fire-retardant resin. It's compatible with all standard sizes of PROGrid® molded and PROGrate® pultruded grating and has continuous anchoring incorporated into the design to eliminate the need for additional anchors. Our embedment angle is available in dark gray and is stocked in 20' lengths.

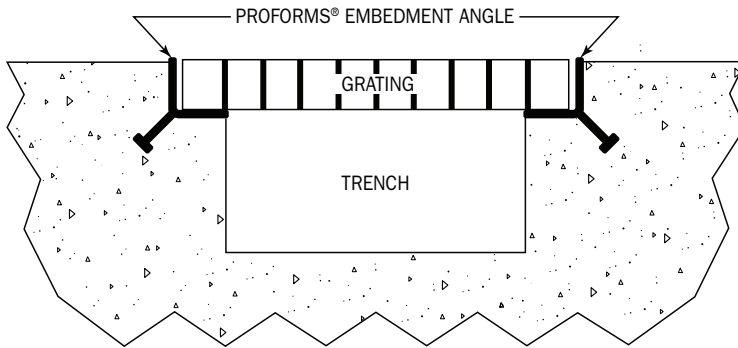

## FEATURES

- Corrosion resistant
- Low conductivity
- UV stable
- Fire retardant
- High strength
- Easy to install

### 1" Embedment Angle

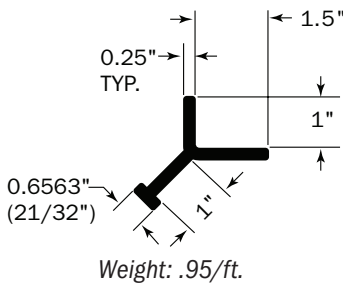

### 1½" Embedment Angle

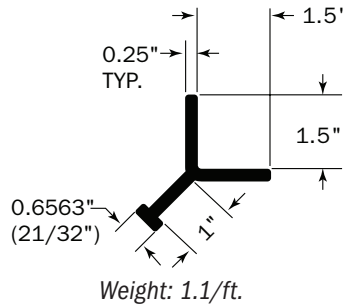

### 2" Embedment Angle

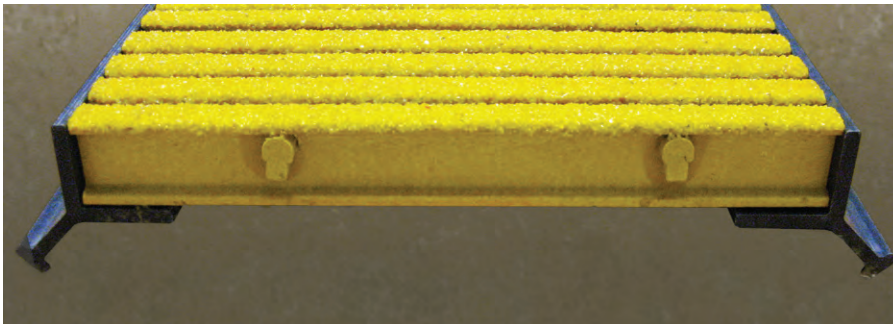
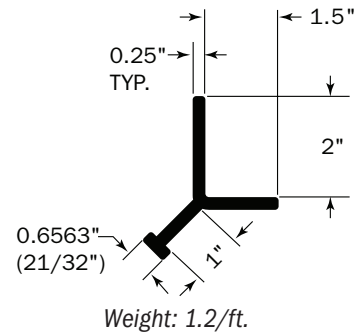



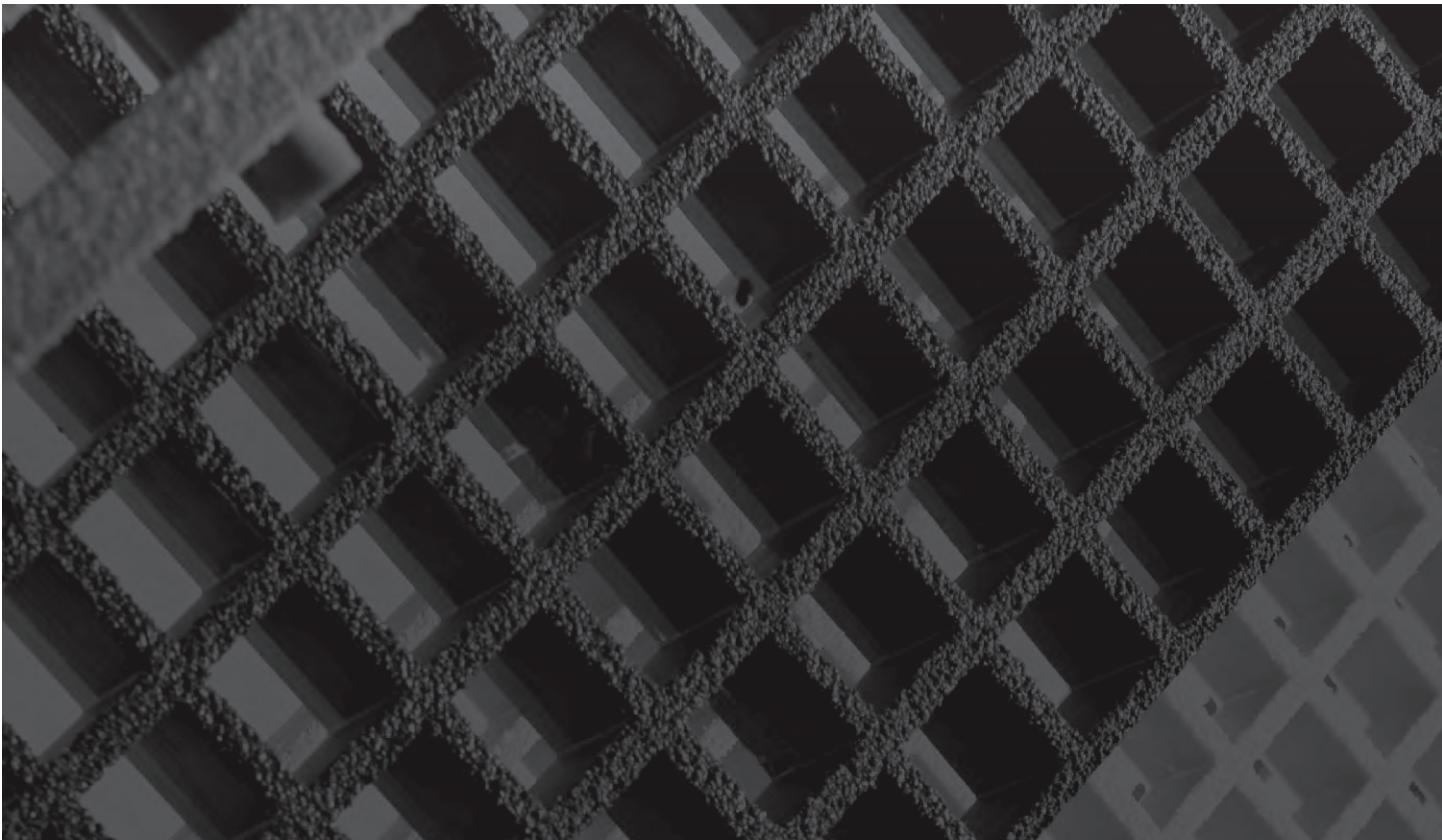

## **SPECIAL ORDER PRODUCTS**

PROGrid® and PROGrate®

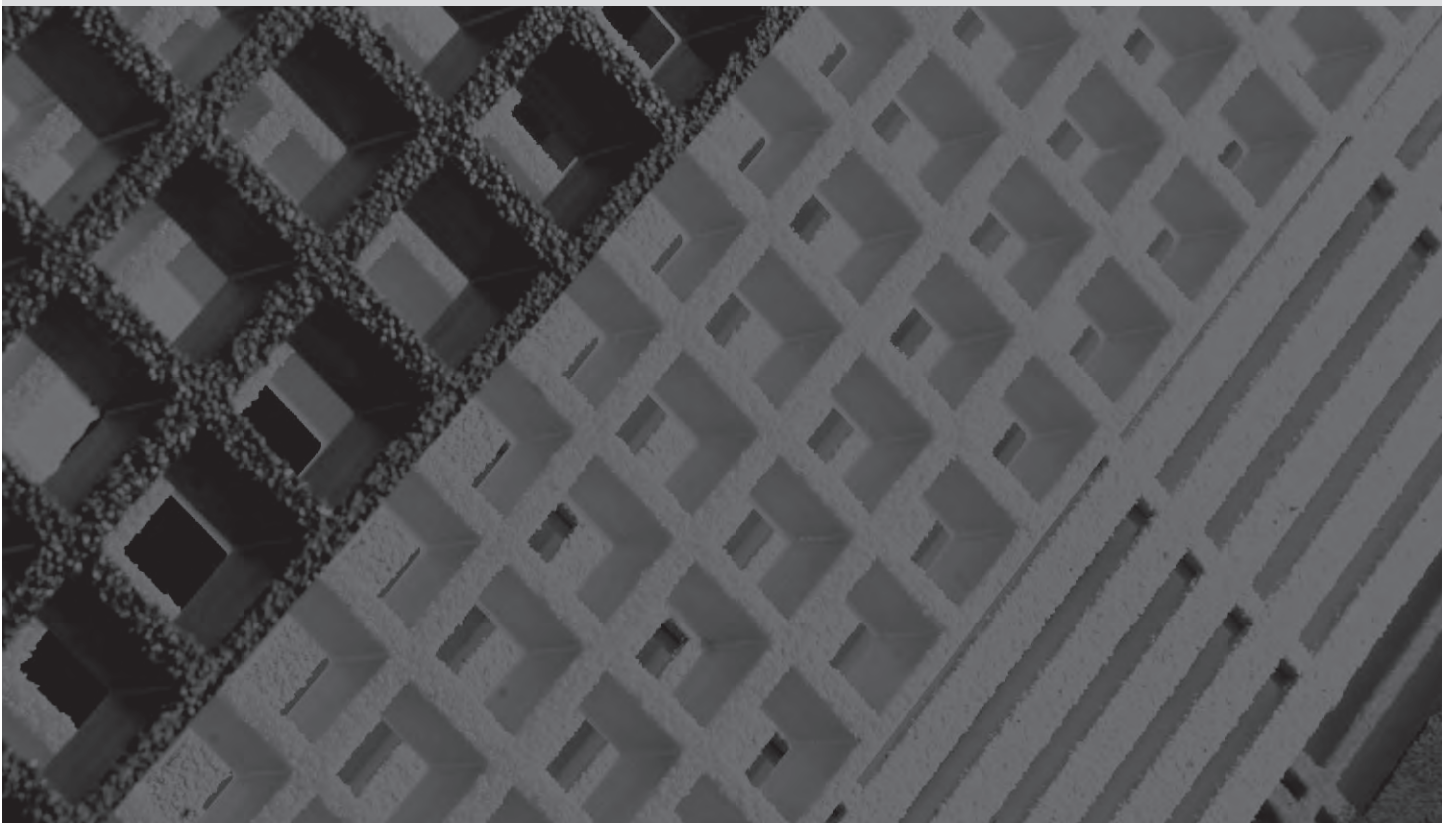

# THE FOLLOWING PROGRID® PRODUCTS ARE ONLY AVAILABLE BY SPECIAL ORDER.

Minimum orders, extended lead times and special-order pricing will apply.

## CONCENTRATED LOAD

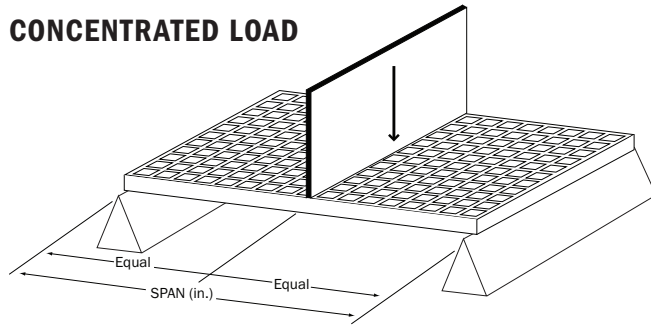

## UNIFORM LOAD

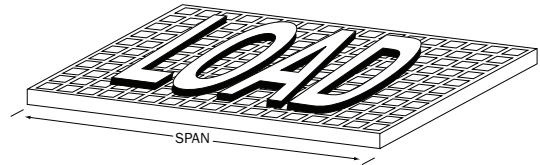

1. The following tables were developed in accordance with the test method developed by the Fiberglass Grating Manufacturers Council (FGMC) of the American Composites Manufacturers Association (ACMA) for the Fiberglass Grating Standard.
2. The designer should not exceed MAXIMUM RECOMMENDED load at any time. MAXIMUM LOAD represents a 4:1 factor of safety on ULTIMATE CAPACITY. ULTIMATE CAPACITY represents MAX LOAD observed at initial fracture.
3. Walking loads for maintenance traffic are typically a live load of 50 PSF. Deflections for worker comfort are typically limited to 0.375" (3/8") or SPAN divided by 120 under full live load. For a firmer feel under full live load or a line load 250 lb/ft of width, limit deflections to 0.25" (1/4") or SPAN divided by 200.
4. The loads represented are for STATIC LOAD CONDITIONS at ambient temperature. Deflections for impact loads or dynamic loads will MULTIPLY the deflections shown by 2. Long term loads will result in added deflection due to creep in the material and will require higher factors of safety to ensure acceptable performance.
5. Deflections are limited to 0.5" (1/2") as recommended by the Fiberglass Grating Manufacturers Council of the American Composites Manufacturers Association.

**1½" x 1" x 6"**  
**Rectangular Grid**  
**1½" Thick**  
**38% Open**



TOP VIEW

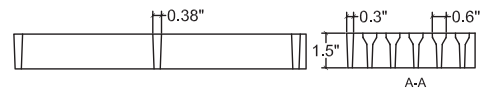
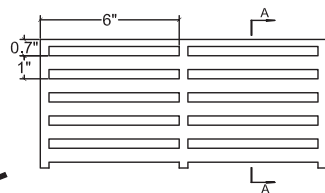

Bearing bars are on 1" centers running in the 12' direction.

Span (inches)	CONCENTRATED LOAD in lb/ft of width								Max Load (lb/ft)	Apparent EI x 10 <sup>6</sup> (lb-in <sup>2</sup> )
	50	100	150	200	250	500	1000	2000		
12	0.001	0.003	0.004	0.005	0.006	0.013	0.025	0.050	4209	1.43
18	0.003	0.007	0.010	0.013	0.017	0.033	0.066	0.133	2810	1.83
24	0.006	0.013	0.019	0.026	0.032	0.065	0.130	0.260	2105	2.22
30	0.012	0.023	0.035	0.047	0.058	0.116	0.233		1684	2.42
36	0.020	0.039	0.059	0.078	0.098	0.196	0.391		1403	2.48
42	0.030	0.061	0.091	0.121	0.151	0.303	0.605		1203	2.55
48	0.045	0.089	0.134	0.178	0.223	0.446			1052	2.58
54	0.063	0.125	0.188	0.251	0.313	0.627			935	2.62
60	0.085	0.171	0.256	0.342	0.427				842	2.63

Span (inches)	UNIFORM LOAD in lb/ft <sup>2</sup>								Max Load (lb/ft <sup>2</sup> )	Apparent EI x 10 <sup>6</sup> (lb-in <sup>2</sup> )
	50	100	150	200	250	500	1000	2000		
12	<0.001	0.002	0.002	0.003	0.004	0.008	0.016	0.031	6623	1.43
18	0.003	0.006	0.009	0.012	0.016	0.031	0.062	0.124	3747	1.83
24	0.008	0.016	0.024	0.032	0.041	0.081	0.162	0.325	2105	2.22
30	0.018	0.036	0.055	0.073	0.091	0.182	0.364		1347	2.42
36	0.037	0.073	0.110	0.147	0.183	0.367			935	2.48
42	0.066	0.132	0.199	0.265	0.331	0.662			687	2.55
48	0.111	0.223	0.334	0.446	0.557				526	2.58
54	0.176	0.353	0.529						416	2.62
60	0.267	0.534							337	2.63

Properties Per Foot of Width				# of Bars	Load Bar Width	Bar Centers	Weight/sq ft
A = 5.76 in <sup>2</sup>	I = 1.14 in <sup>4</sup>	S <sub>T</sub> = 1.94 in <sup>3</sup>	S <sub>B</sub> = 1.24 in <sup>3</sup>	12	0.6"	1"	4.71



**1½" x 1½" x 6"**  
**Rectangular Grid**  
 1½" Thick  
 55% Open

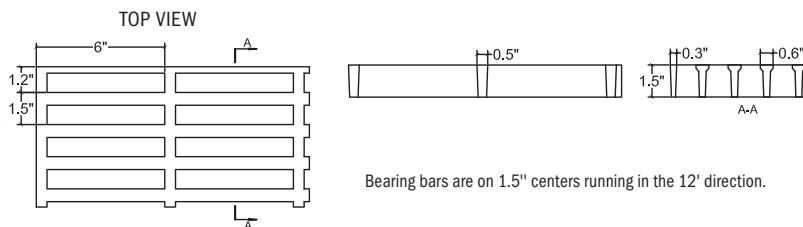

Bearing bars are on 1.5" centers running in the 12' direction.

Span (inches)	CONCENTRATED LOAD in lb/ft of width								Max Load (lb/ft)	Apparent EI x 10 <sup>6</sup> (lb-in <sup>2</sup> )
	50	100	150	200	250	500	1000	2000		
12	0.001	0.003	0.004	0.005	0.006	0.013	0.026	0.051	3601	1.40
18	0.003	0.007	0.010	0.014	0.017	0.035	0.069	0.139	2401	1.75
24	0.007	0.014	0.022	0.029	0.036	0.072	0.144		1800	2.00
30	0.013	0.025	0.038	0.050	0.063	0.126	0.251		1440	2.24
36	0.021	0.042	0.062	0.083	0.104	0.208	0.415		1200	2.34
42	0.032	0.065	0.097	0.130	0.162	0.324	0.649		1029	2.38
48	0.048	0.095	0.143	0.190	0.238	0.476			900	2.42
54	0.067	0.134	0.202	0.269	0.336	0.672			800	2.44
60	0.091	0.183	0.274	0.366	0.457				720	2.46

Span (inches)	UNIFORM LOAD in lb/ft <sup>2</sup>								Max Load (lb/ft <sup>2</sup> )	Apparent EI x 10 <sup>6</sup> (lb-in <sup>2</sup> )
	50	100	150	200	250	500	1000	2000		
12	<0.001	0.002	0.002	0.003	0.004	0.008	0.016	0.032	7202	1.40
18	0.003	0.007	0.010	0.013	0.016	0.033	0.065	0.130	3201	1.75
24	0.009	0.018	0.027	0.036	0.045	0.090	0.180		1800	2.00
30	0.020	0.039	0.059	0.078	0.098	0.196	0.392		1152	2.24
36	0.039	0.078	0.117	0.156	0.195	0.389			800	2.34
42	0.071	0.142	0.213	0.284	0.355				588	2.38
48	0.119	0.238	0.357	0.476	0.595				450	2.42
54	0.189	0.378	0.567						356	2.44
60	0.286	0.572							288	2.46

Properties Per Foot of Width	# of Bars	Load Bar Width	Bar Centers	Weight/sq ft
A = 4.39 in <sup>2</sup>   I = 0.88 in <sup>4</sup>   S <sub>y</sub> = 1.30 in <sup>3</sup>   S <sub>x</sub> = 1.06 in <sup>3</sup>	8	0.6"	1.5"	4.42

**½" x 1½" x 1½"**  
**Square Grid**  
 ½" Thick  
 72% Open

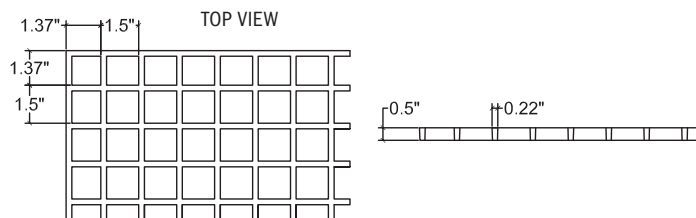
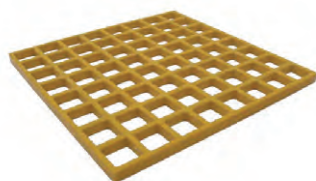

Span (inches)	CONCENTRATED LOAD in lb/ft of width								Max Load (lb/ft)	Apparent EI x 10 <sup>6</sup> (lb-in <sup>2</sup> )
	50	100	150	200	250	500	1000	2000		
12	0.041	0.083	0.124	0.166	0.207				282	0.043
18	0.128	0.256	0.384						188	0.047
24	0.286	0.572							141	0.05

Span (inches)	UNIFORM LOAD in lb/ft <sup>2</sup>								Max Load (lb/ft <sup>2</sup> )	Apparent EI x 10 <sup>6</sup> (lb-in <sup>2</sup> )
	50	100	150	200	250	500	1000	2000		
12	0.026	0.052	0.078	0.104	0.130				361	0.043
18	0.120	0.240	0.360						160	0.047
24	0.357								90	0.05

Properties Per Foot of Width	# of Bars	Load Bar Width	Bar Centers	Weight/sq ft
A = 0.84 in <sup>2</sup>   I = 0.02 in <sup>4</sup>   S = 0.07 in <sup>3</sup>	8	.22"	1.5"	1.33

**½" x 2" x 2"**  
**Square Grid**  
 ½" Thick  
 78% Open

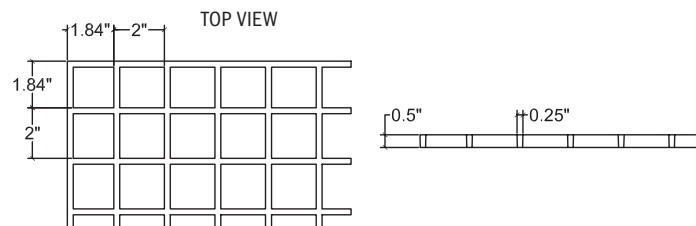

Span (inches)	CONCENTRATED LOAD in lb/ft of width								Max Load (lb/ft)	Apparent EI x 10 <sup>6</sup> (lb-in <sup>2</sup> )
	50	100	150	200	250	500	1000	2000		
12	0.050	0.101	0.151	0.202					236	0.036
18	0.151	0.302	0.453						158	0.04
24	0.329	0.658							118	0.044

Span (inches)	UNIFORM LOAD in lb/ft <sup>2</sup>								Max Load (lb/ft <sup>2</sup> )	Apparent EI x 10 <sup>6</sup> (lb-in <sup>2</sup> )
	50	100	150	200	250	500	1000	2000		
12	0.032	0.063	0.095	0.126	0.158				302	0.036
18	0.142	0.283							134	0.04
24	0.41								75	0.044

Properties Per Foot of Width	# of Bars	Load Bar Width	Bar Centers	Weight/sq ft
A = 0.66 in <sup>2</sup>   I = 0.014 in <sup>4</sup>   S = 0.054 in <sup>3</sup>	6	0.25"	2"	1.01

# THE FOLLOWING PROGRATE® PRODUCTS ARE ONLY AVAILABLE BY SPECIAL ORDER.

Minimum orders, extended lead times and special-order pricing will apply.

## CONCENTRATED LOAD

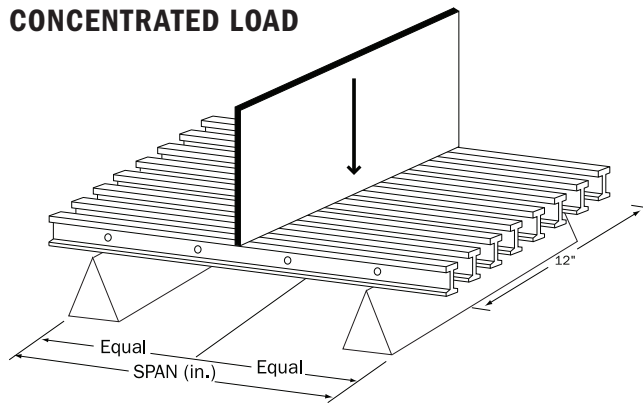

## UNIFORM LOAD

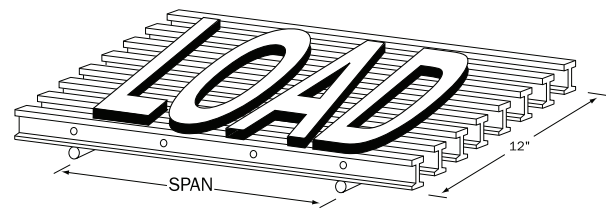

1. The following tables were developed in accordance with the test method developed by the Fiberglass Grating Manufacturers Council (FGMC) of the American Composites Manufacturers Association (ACMA) for the Fiberglass Grating Standard.
2. The designer should not exceed MAXIMUM RECOMMENDED load at any time. ULTIMATE CAPACITY represents MAX LOAD observed at initial fracture.
3. Walking loads for maintenance traffic are typically a live load of 50 PSF. Deflections for worker comfort are typically limited to 0.375" (3/8") or SPAN divided by 120 under full live load. For a firmer feel under full live load or a line load 250 lb/ft of width, limit deflections to 0.25" (1/4") or SPAN divided by 200.
4. The loads represented are for STATIC LOAD CONDITIONS at ambient temperature. Deflections for impact loads or dynamic loads will MULTIPLY the deflections shown by 2. Long term loads will result in added deflection due to creep in the material and will require higher factors of safety to ensure acceptable performance.
5. Deflections are limited to 0.5" (1/2") as recommended by the Fiberglass Grating Manufacturers Council of the American Composites Manufacturers Association.

**T 10-33**  
**T Bearing Bar**  
 1" Thick  
 33% Open

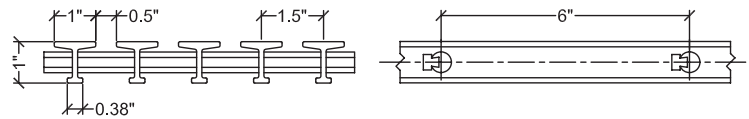

Span (inches)	CONCENTRATED LOAD in lb/ft of width								Max Load (lb/ft)	Apparent EI x 10 <sup>6</sup> (lb-in <sup>2</sup> )
	50	100	150	200	250	500	1000	2000		
12	0.003	0.005	0.008	0.010	0.013	0.026	0.051	0.103	1950	0.70
18	0.007	0.014	0.020	0.027	0.034	0.068	0.135	0.270	1300	0.90
24	0.015	0.029	0.044	0.058	0.073	0.145	0.291	0.582	975	0.99
30	0.028	0.055	0.083	0.110	0.138	0.276	0.551		780	1.02
36	0.047	0.093	0.140	0.187	0.234	0.467			650	1.04
42	0.074	0.147	0.221	0.294	0.368				557	1.05
48	0.109	0.217	0.326	0.435	0.543				488	1.06

Span (inches)	UNIFORM LOAD in lb/ft <sup>2</sup>								Max Load (lb/ft <sup>2</sup> )	Apparent EI x 10 <sup>6</sup> (lb-in <sup>2</sup> )
	50	100	150	200	250	500	1000	2000		
12	0.002	0.003	0.005	0.006	0.008	0.016	0.032	0.064	7599	0.70
18	0.006	0.013	0.019	0.025	0.032	0.063	0.127	0.253	3314	0.90
24	0.018	0.036	0.055	0.073	0.091	0.182	0.364		1957	0.99
30	0.043	0.086	0.129	0.172	0.215	0.431			1258	1.02
36	0.088	0.175	0.263	0.350	0.438				883	1.04
42	0.161	0.322	0.482	0.643					655	1.05
48	0.272	0.543							502	1.06

Properties Per Foot of Width	# of Bars	Load Bar Depth	Bar Centers	Weight/sq ft
A = 2.34 in <sup>2</sup> I = 0.27 in <sup>4</sup> S <sub>x</sub> = 0.78 in <sup>3</sup> S <sub>y</sub> = 0.42 in <sup>3</sup>	8	1"	1.5"	2.25



**T 10-35  
T Bearing Bar  
1" Thick  
35% Open**

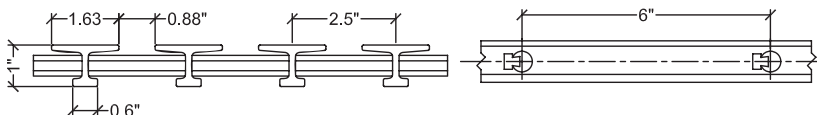

Span (inches)	CONCENTRATED LOAD in lb/ft of width								Max Load (lb/ft)	Apparent EI x 10 <sup>6</sup> (lb-in <sup>2</sup> )
	50	100	150	200	250	500	1000	2000		
12	0.002	0.005	0.007	0.010	0.012	0.024	0.049	0.097	3759	0.74
18	0.006	0.013	0.019	0.026	0.032	0.064	0.128	0.256	2506	0.95
24	0.013	0.027	0.040	0.053	0.067	0.133	0.267	0.533	1880	1.08
30	0.025	0.049	0.074	0.099	0.123	0.247	0.493		1504	1.14
36	0.042	0.084	0.126	0.168	0.209	0.419			1253	1.16
42	0.065	0.131	0.196	0.262	0.327	0.654			1074	1.18
48	0.096	0.192	0.288	0.384	0.480				940	1.20

Span (inches)	UNIFORM LOAD in lb/ft <sup>2</sup>								Max Load (lb/ft <sup>2</sup> )	Apparent EI x 10 <sup>6</sup> (lb-in <sup>2</sup> )
	50	100	150	200	250	500	1000	2000		
12	0.002	0.003	0.004	0.006	0.007	0.015	0.030	0.060	7620	0.74
18	0.006	0.012	0.017	0.023	0.029	0.059	0.119	0.239	3339	0.95
24	0.017	0.033	0.049	0.066	0.083	0.166	0.333	0.666	1898	1.08
30	0.039	0.077	0.115	0.154	0.019	0.385			1204	1.14
36	0.079	0.157	0.235	0.314	0.392				835	1.16
42	0.143	0.286	0.429	0.572					614	1.18
48	0.240	0.480							470	1.20

Properties Per Foot of Width	# of Bars	Load Bar Depth	Bar Centers	Weight/sq ft
A = 2.38 in <sup>2</sup>   I = 0.31 in <sup>4</sup>   S <sub>T</sub> = 0.84 in <sup>3</sup>   S <sub>B</sub> = 0.49 in <sup>3</sup>	5	1"	2.5"	2.00

**T 10-50  
T Bearing Bar  
1" Thick  
50% Open**

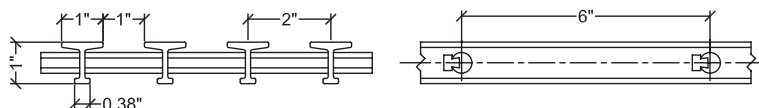

Span (inches)	CONCENTRATED LOAD in lb/ft of width								Max Load (lb/ft)	Apparent EI x 10 <sup>6</sup> (lb-in <sup>2</sup> )
	50	100	150	200	250	500	1000	2000		
12	0.003	0.007	0.010	0.014	0.017	0.034	0.068	0.136	1476	0.53
18	0.009	0.018	0.028	0.037	0.046	0.092	0.184	0.368	984	0.66
24	0.019	0.039	0.058	0.078	0.097	0.195	0.389		738	0.74
30	0.036	0.072	0.108	0.144	0.180	0.361			590	0.78
36	0.062	0.123	0.185	0.246	0.308	0.615			492	0.79
42	0.096	0.193	0.289	0.386	0.482				422	0.80
48	0.142	0.284	0.427	0.569					369	0.81

Span (inches)	UNIFORM LOAD in lb/ft <sup>2</sup>								Max Load (lb/ft <sup>2</sup> )	Apparent EI x 10 <sup>6</sup> (lb-in <sup>2</sup> )
	50	100	150	200	250	500	1000	2000		
12	0.002	0.004	0.006	0.008	0.011	0.021	0.042	0.085	5735	0.53
18	0.009	0.017	0.026	0.035	0.043	0.086	0.173	0.345	2952	0.66
24	0.024	0.048	0.073	0.097	0.122	0.243	0.486		1473	0.74
30	0.056	0.113	0.169	0.225	0.282	0.563			939	0.78
36	0.115	0.231	0.346	0.461	0.577				661	0.79
42	0.211	0.422	0.633						492	0.80
48	0.356								376	0.81

Properties Per Foot of Width	# of Bars	Load Bar Depth	Bar Centers	Weight/sq ft
A = 1.76 in <sup>2</sup>   I = 0.21 in <sup>4</sup>   S <sub>T</sub> = 0.59 in <sup>3</sup>   S <sub>B</sub> = 0.31 in <sup>3</sup>	6	1"	2"	1.81

**T 15-17  
T Bearing Bar  
1½" Thick  
17% Open**

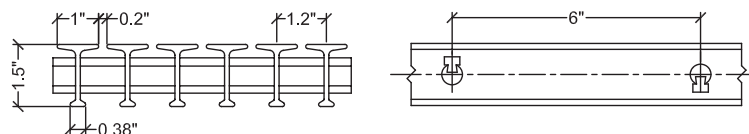
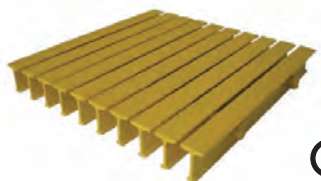

Span (inches)	CONCENTRATED LOAD in lb/ft of width								Max Load (lb/ft)	Apparent EI x 10 <sup>6</sup> (lb-in <sup>2</sup> )
	50	100	150	200	250	500	1000	2000		
12	0.001	0.002	0.003	0.004	0.005	0.010	0.019	0.038	10343	1.89
18	0.002	0.004	0.007	0.009	0.011	0.022	0.045	0.089	6895	2.72
24	0.005	0.009	0.014	0.018	0.023	0.045	0.090	0.180	5172	3.2
30	0.008	0.016	0.024	0.032	0.040	0.080	0.160	0.320	4137	3.52
36	0.0135	0.027	0.0405	0.054	0.0675	0.135	0.27	0.54	3448	3.6
42	0.021	0.043	0.064	0.085	0.107	0.213	0.426		2955	3.62
48	0.032	0.063	0.095	0.127	0.158	0.316	0.633		2586	3.64
54	0.045	0.090	0.134	0.179	0.224	0.448			2298	3.66
60	0.061	0.122	0.183	0.245	0.306	0.611			2069	3.68
66	0.081	0.162	0.243	0.324	0.405				1881	3.7

Span (inches)	UNIFORM LOAD in lb/ft <sup>2</sup>								Max Load (lb/ft <sup>2</sup> )	Apparent EI x 10 <sup>6</sup> (lb-in <sup>2</sup> )
	50	100	150	200	250	500	1000	2000		
12	0.001	0.001	0.002	0.002	0.003	0.006	0.012	0.024	13240	1.89
18	0.002	0.004	0.006	0.008	0.010	0.020	0.042	0.084	5884	2.72
24	0.006	0.011	0.017	0.022	0.028	0.056	0.112	0.225	3310	3.2
30	0.012	0.025	0.037	0.050	0.062	0.125	0.250	0.500	2118	3.52
36	0.025	0.051	0.076	0.101	0.127	0.253	0.506		1471	3.6
42	0.047	0.093	0.140	0.187	0.233	0.466			1081	3.62
48	0.079	0.158	0.237	0.316	0.396				827	3.64
54	0.126	0.252	0.378	0.504	0.630				654	3.66
60	0.191	0.382	0.573						530	3.68
66	0.278	0.556							438	3.7

Properties Per Foot of Width	# of Bars	Load Bar Depth	Bar Centers	Weight/sq ft
A = 3.08 in <sup>2</sup>   I = 0.88 in <sup>4</sup>   S <sub>T</sub> = 1.38 in <sup>3</sup>   S <sub>B</sub> = 1.02 in <sup>3</sup>	10	1.5"	1.2"	3.39



**T 15-33**  
**T Bearing Bar**  
 1½" Thick  
 33% Open

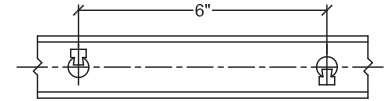
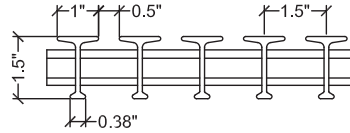
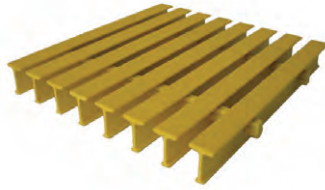

Span (inches)	CONCENTRATED LOAD in lb/ft of width								Max Load (lb/ft)	Apparent EI x 10 <sup>6</sup> (lb-in <sup>2</sup> )
	50	100	150	200	250	500	1000	2000		
12	0.001	0.002	0.003	0.004	0.005	0.011	0.021	0.042	8235	1.71
18	0.003	0.005	0.008	0.011	0.013	0.026	0.053	0.106	5490	2.3
24	0.005	0.011	0.016	0.022	0.027	0.054	0.109	0.217	4118	2.65
30	0.010	0.020	0.031	0.041	0.051	0.102	0.205	0.409	3294	2.75
36	0.017	0.035	0.052	0.070	0.087	0.174	0.348	0.697	2745	2.79
42	0.027	0.055	0.082	0.109	0.136	0.273	0.545		2353	2.83
48	0.040	0.081	0.121	0.161	0.201	0.403			2059	2.86
54	0.057	0.114	0.170	0.227	0.284	0.568			1830	2.89
60	0.077	0.155	0.232	0.309	0.387				1647	2.91
66	0.102	0.204	0.307	0.409	0.511				1497	2.93

Span (inches)	UNIFORM LOAD in lb/ft <sup>2</sup>								Max Load (lb/ft <sup>2</sup> )	Apparent EI x 10 <sup>6</sup> (lb-in <sup>2</sup> )
	50	100	150	200	250	500	1000	2000		
12	0.001	0.001	0.002	0.003	0.003	0.007	0.013	0.026	10541	1.71
18	0.002	0.005	0.007	0.010	0.012	0.025	0.050	0.099	4685	2.3
24	0.007	0.014	0.020	0.027	0.034	0.068	0.136	0.272	2635	2.65
30	0.016	0.032	0.048	0.064	0.080	0.160	0.320	0.639	1687	2.75
36	0.033	0.065	0.098	0.131	0.163	0.327	0.653		1171	2.79
42	0.060	0.119	0.179	0.239	0.298	0.597			861	2.83
48	0.101	0.201	0.302	0.403	0.503				659	2.86
54	0.160	0.319	0.479	0.638					521	2.89
60	0.242	0.483							422	2.91
66	0.351								348	2.93

Properties Per Foot of Width	# of Bars	Load Bar Depth	Bar Centers	Weight/sq ft
A = 2.47 in <sup>2</sup> I = 0.70 in <sup>4</sup> S <sub>x</sub> = 1.10 in <sup>3</sup> S <sub>y</sub> = 0.82 in <sup>3</sup>	8	1.5"	1.5"	2.81

**T 15-50**  
**T Bearing Bar**  
 1½" Thick  
 50% Open

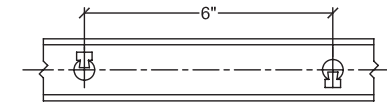
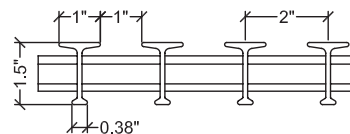
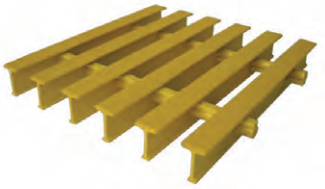

Span (inches)	CONCENTRATED LOAD in lb/ft of width								Max Load (lb/ft)	Apparent EI x 10 <sup>6</sup> (lb-in <sup>2</sup> )
	50	100	150	200	250	500	1000	2000		
12	0.001	0.003	0.004	0.005	0.006	0.013	0.026	0.051	5210	1.41
18	0.003	0.007	0.010	0.013	0.017	0.033	0.066	0.132	3473	1.84
24	0.007	0.014	0.021	0.029	0.036	0.072	0.143	0.286	2605	2.01
30	0.013	0.027	0.040	0.054	0.067	0.134	0.268	0.536	2084	2.1
36	0.023	0.045	0.068	0.090	0.113	0.225	0.450		1737	2.16
42	0.035	0.070	0.104	0.139	0.174	0.348	0.695		1489	2.22
48	0.051	0.102	0.153	0.204	0.255	0.510			1303	2.26
54	0.072	0.144	0.216	0.288	0.360				1158	2.28
60	0.098	0.196	0.293	0.391	0.489				1042	2.3
66	0.129	0.258	0.387	0.516	0.645				947	2.32

Span (inches)	UNIFORM LOAD in lb/ft <sup>2</sup>								Max Load (lb/ft <sup>2</sup> )	Apparent EI x 10 <sup>6</sup> (lb-in <sup>2</sup> )
	50	100	150	200	250	500	1000	2000		
12	0.001	0.002	0.002	0.003	0.004	0.008	0.016	0.032	6669	1.41
18	0.003	0.006	0.009	0.012	0.015	0.031	0.062	0.124	3464	1.84
24	0.009	0.018	0.027	0.036	0.045	0.089	0.179	0.357	1667	2.01
30	0.021	0.042	0.063	0.084	0.105	0.209	0.419		1067	2.1
36	0.042	0.084	0.127	0.169	0.211	0.422			741	2.16
42	0.076	0.152	0.228	0.304	0.380				545	2.22
48	0.127	0.255	0.382	0.510	0.637				417	2.26
54	0.202	0.405	0.607						329	2.28
60	0.306	0.611							267	2.3
66	0.444								220	2.32

Properties Per Foot of Width	# of Bars	Load Bar Depth	Bar Centers	Weight/sq ft
A = 1.85 in <sup>2</sup> I = 0.53 in <sup>4</sup> S <sub>x</sub> = 0.83 in <sup>3</sup> S <sub>y</sub> = 0.61 in <sup>3</sup>	6	1.5"	2"	2.23



**T 20-33  
T Bearing Bar  
2" Thick  
33% Open**

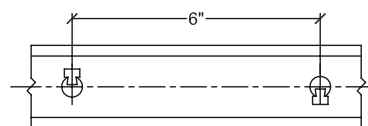
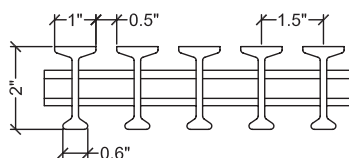
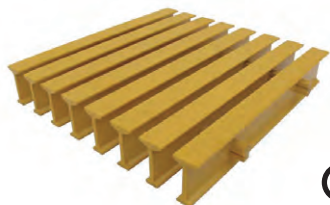

Span (inches)	CONCENTRATED LOAD in lb/ft of width									Max Load (lb/ft)	Apparent EI x 10 <sup>6</sup> (lb-in <sup>2</sup> )
	50	100	150	200	250	500	1000	2000	2000		
12	0.001	0.001	0.002	0.002	0.003	0.005	0.010	0.020	0.020	16215	3.60
18	0.001	0.002	0.003	0.004	0.005	0.010	0.020	0.040	0.040	10810	6.07
24	0.002	0.004	0.005	0.007	0.009	0.018	0.037	0.073	0.073	8108	7.89
30	0.003	0.006	0.009	0.012	0.015	0.030	0.060	0.121	0.121	6486	9.32
36	0.005	0.010	0.014	0.019	0.024	0.048	0.096	0.192	0.192	5405	10.10
42	0.007	0.015	0.022	0.029	0.036	0.073	0.146	0.291	0.291	4633	10.60
48	0.010	0.021	0.031	0.042	0.052	0.104	0.208	0.417	0.417	4054	11.06
54	0.015	0.029	0.044	0.058	0.073	0.146	0.291	0.583	0.583	3603	11.26
60	0.020	0.040	0.059	0.079	0.099	0.198	0.396			3243	11.36
66	0.026	0.052	0.078	0.105	0.131	0.261	0.523			2948	11.46
72	0.034	0.068	0.101	0.135	0.169	0.338	0.676			2703	11.50

Span (inches)	UNIFORM LOAD in lb/ft <sup>2</sup>									Max Load (lb/ft <sup>2</sup> )	Apparent EI x 10 <sup>6</sup> (lb-in <sup>2</sup> )
	50	100	150	200	250	500	1000	2000	2000		
12	<0.001	0.001	0.001	0.001	0.002	0.003	0.006	0.012	0.012	20269	3.60
18	0.001	0.002	0.003	0.004	0.005	0.009	0.019	0.038	0.038	13524	6.07
24	0.002	0.005	0.007	0.009	0.011	0.023	0.046	0.091	0.091	7398	7.89
30	0.005	0.009	0.014	0.019	0.024	0.047	0.094	0.189	0.189	5437	9.32
36	0.009	0.018	0.027	0.036	0.045	0.090	0.180	0.361	0.361	3612	10.10
42	0.016	0.032	0.048	0.064	0.080	0.159	0.319	0.637	0.637	2635	10.60
48	0.026	0.052	0.078	0.104	0.130	0.260	0.521			2030	11.06
54	0.041	0.082	0.123	0.164	0.205	0.410				1600	11.26
60	0.062	0.124	0.186	0.248	0.309	0.619				1295	11.36
66	0.090	0.180	0.269	0.359	0.449					1070	11.46
72	0.127	0.254	0.380	0.507	0.634					899	11.50

Properties Per Foot of Width	# of Bars	Load Bar Depth	Bar Centers	Weight/sq ft
A = 4.34 in <sup>2</sup>   I = 2.11 in <sup>4</sup>   S <sub>y</sub> = 2.64 in <sup>3</sup>   S <sub>x</sub> = 1.76 in <sup>3</sup>	8	2"	1.5"	4.44

**I 10-50  
I Bearing Bar  
1" Thick  
50% Open**

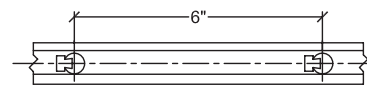
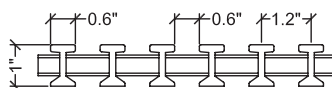
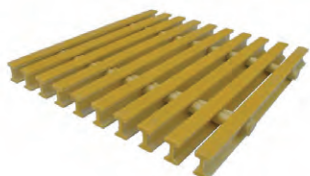

Span (inches)	CONCENTRATED LOAD in lb/ft of width									Max Load (lb/ft)	Apparent EI x 10 <sup>6</sup> (lb-in <sup>2</sup> )
	50	100	150	200	250	500	1000	2000	2000		
12	0.001	0.003	0.004	0.005	0.007	0.013	0.026	0.053	0.053	7185	1.36
18	0.004	0.007	0.011	0.015	0.018	0.037	0.074	0.147	0.147	4790	1.65
24	0.008	0.015	0.023	0.031	0.038	0.077	0.153	0.306	0.306	3593	1.88
30	0.014	0.028	0.042	0.057	0.071	0.141	0.283	0.565	0.565	2874	1.99
36	0.024	0.048	0.073	0.097	0.121	0.242	0.484			2395	2.01
42	0.038	0.076	0.114	0.152	0.190	0.380				2053	2.03
48	0.056	0.112	0.169	0.225	0.281	0.562				1796	2.05
54	0.080	0.159	0.239	0.318	0.398					1597	2.06
60	0.109	0.217	0.326	0.435	0.543					1437	2.07
66	0.144	0.288	0.432	0.576						1307	2.08
72	0.186	0.372	0.558							1198	2.09

Span (inches)	UNIFORM LOAD in lb/ft <sup>2</sup>									Max Load (lb/ft <sup>2</sup> )	Apparent EI x 10 <sup>6</sup> (lb-in <sup>2</sup> )
	50	100	150	200	250	500	1000	2000	2000		
12	0.001	0.002	0.002	0.003	0.004	0.008	0.017	0.033	0.033	11887	1.36
18	0.003	0.007	0.010	0.014	0.017	0.035	0.069	0.138	0.138	6299	1.65
24	0.010	0.019	0.029	0.038	0.048	0.096	0.191	0.383	0.383	3621	1.88
30	0.022	0.044	0.066	0.088	0.110	0.221	0.442			2308	1.99
36	0.045	0.091	0.136	0.181	0.227	0.453				1591	2.01
42	0.083	0.166	0.249	0.333	0.416					1175	2.03
48	0.140	0.281	0.421	0.562						898	2.05
54	0.224	0.448	0.672							709	2.06
60	0.340	0.679								638	2.07

Properties Per Foot of Width	# of Bars	Load Bar Depth	Bar Centers	Weight/sq ft
A = 3.05 in <sup>2</sup>   I = 0.39 in <sup>4</sup>   S = 0.77 in <sup>3</sup>	10	1"	1.2"	2.97



**I 15-50  
I Bearing Bar  
1½" Thick  
50% Open**

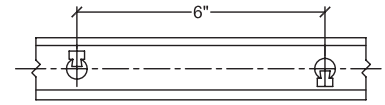
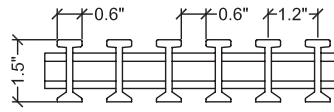
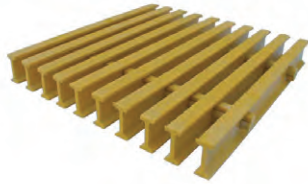

Span (inches)	CONCENTRATED LOAD in lb/ft of width									Max Load (lb/ft)	Apparent EI x 10 <sup>6</sup> (lb-in <sup>2</sup> )
	50	100	150	200	250	500	1000	2000			
12	0.001	0.001	0.002	0.003	0.004	0.007	0.015	0.029	11055	2.46	
18	0.002	0.003	0.005	0.006	0.008	0.015	0.030	0.061	7370	4.00	
24	0.003	0.006	0.009	0.012	0.015	0.030	0.060	0.119	5528	4.84	
30	0.005	0.011	0.016	0.021	0.027	0.054	0.107	0.214	4422	5.25	
36	0.009	0.018	0.027	0.036	0.045	0.089	0.178	0.356	3685	5.46	
42	0.014	0.028	0.042	0.056	0.070	0.139	0.279	0.558	3159	5.53	
48	0.021	0.041	0.062	0.083	0.103	0.206	0.413		2764	5.58	
54	0.029	0.059	0.088	0.117	0.146	0.293	0.586		2457	5.60	
60	0.040	0.080	0.120	0.160	0.200	0.401			2211	5.61	
66	0.053	0.106	0.160	0.213	0.266	0.532			2010	5.63	
72	0.069	0.138	0.207	0.276	0.345	0.689			1843	5.64	

Span (inches)	UNIFORM LOAD in lb/ft <sup>2</sup>									Max Load (lb/ft <sup>2</sup> )	Apparent EI x 10 <sup>6</sup> (lb-in <sup>2</sup> )
	50	100	150	200	250	500	1000	2000			
12	<0.001	0.001	0.001	0.002	0.002	0.005	0.009	0.018	13992	2.46	
18	0.001	0.003	0.004	0.006	0.007	0.014	0.028	0.057	9328	4.00	
24	0.004	0.007	0.011	0.015	0.019	0.037	0.074	0.149	5878	4.84	
30	0.008	0.017	0.025	0.034	0.042	0.084	0.168	0.335	3486	5.25	
36	0.017	0.033	0.050	0.067	0.083	0.167	0.334	0.668	2485	5.46	
42	0.031	0.061	0.092	0.122	0.153	0.305	0.610		1806	5.53	
48	0.052	0.103	0.155	0.206	0.258	0.516			1384	5.58	
54	0.082	0.165	0.247	0.330	0.412				1091	5.60	
60	0.125	0.250	0.376	0.501	0.626				886	5.61	
66	0.183	0.366	0.548						730	5.63	
72	0.259	0.517							614	5.64	

Properties Per Foot of Width	# of Bars	Load Bar Depth	Bar Centers	Weight/sq ft
A = 3.89 in <sup>2</sup> I = 1.11 in <sup>4</sup> S = 1.47 in <sup>3</sup>	10	1.5"	1.2"	3.60

**I 10-40-ADA  
I Bearing Bar  
1" Thick  
40% Open**

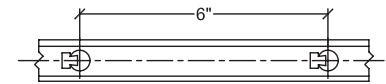
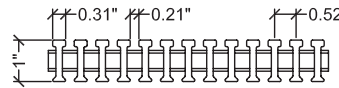

Span (inches)	CONCENTRATED LOAD in lb/ft of width									Max Load (lb/ft)	Apparent EI x 10 <sup>6</sup> (lb-in <sup>2</sup> )
	50	100	150	200	250	500	1000	2000			
12	0.001	0.002	0.003	0.004	0.005	0.009	0.018	0.036	9005	1.99	
18	0.003	0.006	0.009	0.011	0.014	0.029	0.057	0.115	6003	2.12	
24	0.006	0.013	0.019	0.026	0.032	0.064	0.129	0.257	4503	2.24	
30	0.012	0.024	0.036	0.048	0.060	0.120	0.239	0.479	3602	2.35	
36	0.020	0.040	0.060	0.080	0.100	0.201	0.402		3002	2.42	
42	0.032	0.063	0.095	0.126	0.158	0.315			2573	2.45	
48	0.047	0.093	0.140	0.187	0.233	0.466			2251	2.47	
54	0.066	0.132	0.198	0.265	0.331	0.661			2001	2.48	
60	0.090	0.181	0.271	0.361	0.452				1800	2.49	
66	0.120	0.240	0.359	0.479	0.599				1637	2.50	
72	0.155	0.310	0.465	0.620					1500	2.51	

Span (inches)	UNIFORM LOAD in lb/ft <sup>2</sup>									Max Load (lb/ft <sup>2</sup> )	Apparent EI x 10 <sup>6</sup> (lb-in <sup>2</sup> )
	50	100	150	200	250	500	1000	2000			
12	0.001	0.001	0.002	0.002	0.003	0.006	0.011	0.023	11526	1.99	
18	0.003	0.005	0.008	0.011	0.013	0.027	0.054	0.107	5123	2.12	
24	0.008	0.016	0.024	0.032	0.040	0.080	0.161	0.321	2882	2.24	
30	0.019	0.037	0.056	0.075	0.094	0.187	0.374		1844	2.35	
36	0.038	0.075	0.113	0.151	0.188	0.377			1281	2.42	
42	0.069	0.138	0.207	0.276	0.345				941	2.45	
48	0.117	0.233	0.350	0.466					720	2.47	
54	0.186	0.372	0.558						569	2.48	
60	0.282	0.565							461	2.49	
66	0.412								381	2.5	
72	0.581								320	2.51	

Properties Per Foot of Width	# of Bars	Load Bar Depth	Bar Centers	Weight/sq ft
A = 4.44 in <sup>2</sup> I = 0.49 in <sup>4</sup> S = 0.98 in <sup>3</sup>	23	1"	.52"	4.08



**I 10-50-ADA**  
**I Bearing Bar**  
 1" Thick  
 50% Open

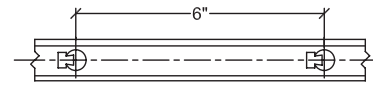
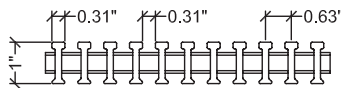

Span (inches)	CONCENTRATED LOAD in lb/ft of width								Max Load (lb/ft)	Apparent EI x 10 <sup>6</sup> (lb-in <sup>2</sup> )
	50	100	150	200	250	500	1000	2000		
12	0.001	0.003	0.004	0.006	0.007	0.014	0.028	0.056	7495	1.29
18	0.003	0.007	0.010	0.014	0.017	0.035	0.069	0.139	4997	1.75
24	0.007	0.015	0.022	0.030	0.037	0.074	0.148	0.295	3748	1.95
30	0.014	0.028	0.042	0.055	0.069	0.139	0.277		2998	2.03
36	0.024	0.048	0.071	0.095	0.119	0.238	0.476		2498	2.04
42	0.037	0.075	0.112	0.150	0.187	0.375			2141	2.06
48	0.056	0.111	0.167	0.223	0.278				1874	2.07
54	0.079	0.158	0.237	0.315	0.394				1666	2.08
60	0.108	0.215	0.323	0.431	0.538				1499	2.09
66	0.143	0.285	0.428	0.570					1363	2.10
72	0.184	0.369	0.553						1250	2.11

Span (inches)	UNIFORM LOAD in lb/ft <sup>2</sup>								Max Load (lb/ft <sup>2</sup> )	Apparent EI x 10 <sup>6</sup> (lb-in <sup>2</sup> )
	50	100	150	200	250	500	1000	2000		
12	0.001	0.002	0.003	0.003	0.004	0.009	0.017	0.035	9594	1.29
18	0.003	0.007	0.010	0.013	0.016	0.033	0.065	0.130	4264	1.75
24	0.009	0.018	0.028	0.037	0.046	0.092	0.185	0.369	2398	1.95
30	0.022	0.043	0.065	0.087	0.108	0.216	0.433		1535	2.03
36	0.045	0.089	0.134	0.179	0.223	0.447			1066	2.04
42	0.082	0.164	0.246	0.328	0.410				783	2.06
48	0.139	0.278	0.417						600	2.07
54	0.222	0.444	0.665						474	2.08
60	0.336	0.673							383	2.09
66	0.490								317	2.1
72	0.691								267	2.11

Properties Per Foot of Width	# of Bars	Load Bar Depth	Bar Centers	Weight/sq ft
A = 3.67 in <sup>2</sup> I = 0.40 in <sup>4</sup> S = 0.80 in <sup>3</sup>	19	1"	0.63"	3.50

**I 10-60-ADA**  
**I Bearing Bar**  
 1" Thick  
 60% Open

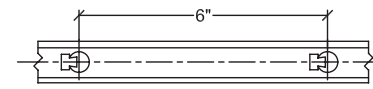
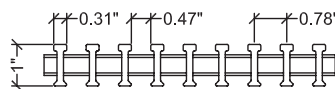
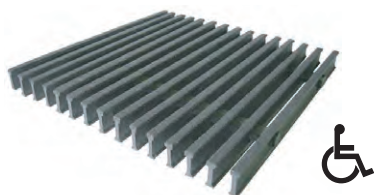

Span (inches)	CONCENTRATED LOAD in lb/ft of width								Max Load (lb/ft)	Apparent EI x 10 <sup>6</sup> (lb-in <sup>2</sup> )
	50	100	150	200	250	500	1000	2000		
12	0.002	0.003	0.005	0.006	0.008	0.015	0.030	0.060	6181	1.20
18	0.004	0.008	0.012	0.016	0.021	0.041	0.082	0.164	4121	1.48
24	0.009	0.017	0.026	0.035	0.044	0.087	0.175	0.349	3091	1.65
30	0.016	0.033	0.049	0.065	0.082	0.164	0.327		2472	1.72
36	0.028	0.055	0.083	0.110	0.138	0.276			2060	1.76
42	0.043	0.086	0.129	0.172	0.214	0.429			1766	1.80
48	0.063	0.127	0.190	0.253	0.316				1545	1.82
54	0.089	0.178	0.267	0.357	0.446				1374	1.84
60	0.121	0.242	0.363	0.484	0.605				1237	1.86
66	0.160	0.320	0.480	0.641					1124	1.87
72	0.207	0.414	0.620						1030	1.88

Span (inches)	UNIFORM LOAD in lb/ft <sup>2</sup>								Max Load (lb/ft <sup>2</sup> )	Apparent EI x 10 <sup>6</sup> (lb-in <sup>2</sup> )
	50	100	150	200	250	500	1000	2000		
12	0.001	0.002	0.003	0.004	0.005	0.009	0.019	0.038	7912	1.20
18	0.004	0.008	0.012	0.015	0.019	0.038	0.077	0.154	3516	1.48
24	0.011	0.022	0.033	0.044	0.055	0.109	0.218	0.436	1978	1.65
30	0.026	0.051	0.077	0.102	0.128	0.255			1266	1.72
36	0.052	0.104	0.155	0.207	0.259				879	1.76
42	0.094	0.188	0.281	0.375					646	1.80
48	0.158	0.316	0.475	0.633					494	1.82
54	0.251	0.501							391	1.84
60	0.378								316	1.86
66	0.551								261	1.87
72	0.776								220	1.88

Properties Per Foot of Width	# of Bars	Load Bar Depth	Bar Centers	Weight/sq ft
A = 2.90 in <sup>2</sup> I = 0.32 in <sup>4</sup> S = 0.64 in <sup>3</sup>	15	1"	0.78"	2.92





**I 15-40-ADA**  
**I Bearing Bar**  
 1½" Thick  
 40% Open

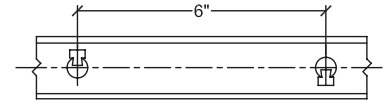
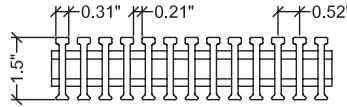
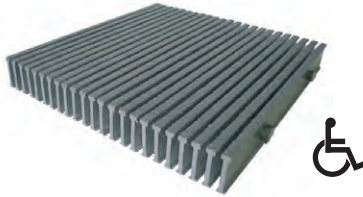

Span (inches)	CONCENTRATED LOAD in lb/ft of width								Max Load (lb/ft)	Apparent EI x 10 <sup>6</sup> (lb-in <sup>2</sup> )
	50	100	150	200	250	500	1000	2000		
12	0.001	0.001	0.002	0.002	0.003	0.005	0.011	0.021	15057	3.40
18	0.001	0.002	0.003	0.004	0.006	0.011	0.022	0.045	10038	5.42
24	0.002	0.005	0.007	0.009	0.012	0.023	0.047	0.094	7528	6.16
30	0.004	0.008	0.013	0.017	0.021	0.042	0.085	0.170	6023	6.63
36	0.007	0.014	0.022	0.029	0.036	0.072	0.143	0.287	5019	6.78
42	0.011	0.022	0.034	0.045	0.056	0.112	0.224	0.447	4302	6.90
48	0.016	0.033	0.049	0.065	0.082	0.163	0.327		3764	7.05
54	0.023	0.046	0.069	0.092	0.115	0.229	0.459		3346	7.15
60	0.031	0.063	0.094	0.125	0.157	0.313			3011	7.18
66	0.042	0.083	0.125	0.166	0.208	0.416			2738	7.20
72	0.054	0.108	0.162	0.215	0.269	0.539			2509	7.22

Span (inches)	UNIFORM LOAD in lb/ft <sup>2</sup>								Max Load (lb/ft <sup>2</sup> )	Apparent EI x 10 <sup>6</sup> (lb-in <sup>2</sup> )
	50	100	150	200	250	500	1000	2000		
12	0.000	0.001	0.001	0.001	0.002	0.003	0.007	0.013	19273	3.40
18	0.001	0.002	0.003	0.004	0.005	0.011	0.021	0.042	8566	5.42
24	0.003	0.006	0.009	0.012	0.015	0.029	0.058	0.117	4818	6.16
30	0.007	0.013	0.020	0.027	0.033	0.066	0.133	0.265	3084	6.63
36	0.013	0.027	0.040	0.054	0.067	0.134	0.269		2141	6.78
42	0.024	0.049	0.073	0.098	0.122	0.245			1573	6.9
48	0.041	0.082	0.123	0.163	0.204				1205	7.05
54	0.065	0.129	0.194	0.258	0.323				952	7.15
60	0.098	0.196	0.294	0.392	0.490				771	7.18
66	0.143	0.286	0.429						637	7.2
72	0.202	0.404							535	7.22

Properties Per Foot of Width	# of Bars	Load Bar Depth	Bar Centers	Weight/sq ft
A = 6.24 in <sup>2</sup> I = 1.38 in <sup>4</sup> S = 1.84 in <sup>3</sup>	23	1.5"	0.52"	5.32

**I 15-50-ADA**  
**I Bearing Bar**  
 1½" Thick  
 50% Open

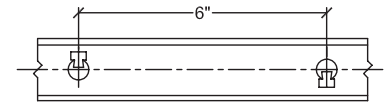
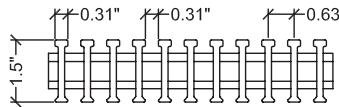
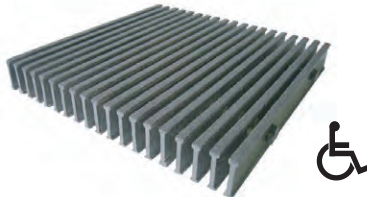

Span (inches)	CONCENTRATED LOAD in lb/ft of width								Max Load (lb/ft)	Apparent EI x 10 <sup>6</sup> (lb-in <sup>2</sup> )
	50	100	150	200	250	500	1000	2000		
12	0.001	0.001	0.002	0.002	0.003	0.006	0.011	0.022	12052	3.26
18	0.001	0.003	0.004	0.006	0.007	0.014	0.028	0.056	8035	4.32
24	0.003	0.006	0.009	0.012	0.015	0.029	0.058	0.116	6026	4.96
30	0.005	0.010	0.016	0.021	0.026	0.052	0.104	0.208	4821	5.42
36	0.009	0.017	0.026	0.035	0.043	0.086	0.173	0.346	4017	5.62
42	0.013	0.027	0.040	0.054	0.067	0.134	0.269		3444	5.74
48	0.020	0.040	0.060	0.079	0.099	0.199	0.397		3013	5.80
54	0.028	0.056	0.085	0.113	0.141	0.282			2678	5.82
60	0.039	0.077	0.116	0.154	0.193	0.385			2410	5.84
66	0.051	0.102	0.153	0.204	0.256	0.511			2191	5.86
72	0.066	0.132	0.198	0.264	0.331				2009	5.88

Span (inches)	UNIFORM LOAD in lb/ft <sup>2</sup>								Max Load (lb/ft <sup>2</sup> )	Apparent EI x 10 <sup>6</sup> (lb-in <sup>2</sup> )
	50	100	150	200	250	500	1000	2000		
12	0.000	0.001	0.001	0.001	0.002	0.003	0.007	0.014	15427	3.26
18	0.001	0.003	0.004	0.005	0.007	0.013	0.026	0.053	6856	4.32
24	0.004	0.007	0.011	0.015	0.018	0.036	0.073	0.145	3857	4.96
30	0.008	0.016	0.024	0.032	0.041	0.081	0.162	0.324	2468	5.42
36	0.016	0.032	0.049	0.065	0.081	0.162	0.324		1714	5.62
42	0.029	0.059	0.088	0.118	0.147	0.294			1259	5.74
48	0.050	0.099	0.149	0.199	0.248				964	5.8
54	0.079	0.159	0.238	0.317	0.396				762	5.82
60	0.120	0.241	0.361	0.482					617	5.84
66	0.176	0.351							510	5.86
72	0.248	0.496							429	5.88

Properties Per Foot of Width	# of Bars	Load Bar Depth	Bar Centers	Weight/sq ft
A = 5.15 in <sup>2</sup> I = 1.14 in <sup>4</sup> S = 1.52 in <sup>3</sup>	19	1.5"	0.63"	4.64

**I 15-60-ADA**  
**I Bearing Bar**  
 1½" Thick  
 60% Open

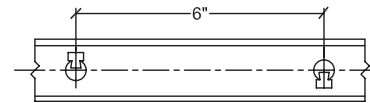
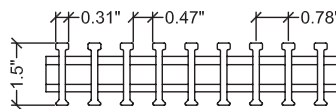
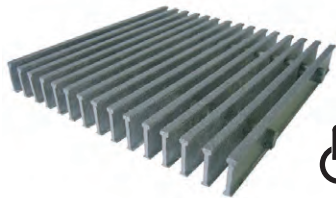

Span (inches)	CONCENTRATED LOAD in lb/ft of width								Max Load (lb/ft)	Apparent EI x 10 <sup>6</sup> (lb-in <sup>2</sup> )
	50	100	150	200	250	500	1000	2000		
12	0.001	0.001	0.002	0.003	0.003	0.006	0.013	0.026	10046	2.80
18	0.002	0.003	0.005	0.007	0.008	0.017	0.034	0.068	6697	3.60
24	0.003	0.007	0.010	0.014	0.017	0.035	0.069	0.139	5023	4.15
30	0.006	0.013	0.019	0.025	0.032	0.063	0.126	0.253	4018	4.45
36	0.011	0.021	0.032	0.042	0.053	0.106	0.212	0.424	3349	4.58
42	0.017	0.033	0.050	0.067	0.083	0.166	0.333		2870	4.64
48	0.025	0.049	0.074	0.099	0.124	0.247	0.494		2511	4.66
54	0.035	0.070	0.105	0.140	0.174	0.349			2232	4.70
60	0.048	0.095	0.143	0.191	0.238	0.477			2009	4.72
66	0.063	0.126	0.190	0.253	0.316				1826	4.74
72	0.082	0.163	0.245	0.327	0.408				1674	4.76

Span (inches)	UNIFORM LOAD in lb/ft <sup>2</sup>								Max Load (lb/ft <sup>2</sup> )	Apparent EI x 10 <sup>6</sup> (lb-in <sup>2</sup> )
	50	100	150	200	250	500	1000	2000		
12	0.000	0.001	0.001	0.002	0.002	0.004	0.008	0.016	12858	2.80
18	0.002	0.003	0.005	0.006	0.008	0.016	0.032	0.063	5715	3.60
24	0.004	0.009	0.013	0.017	0.022	0.043	0.087	0.173	3215	4.15
30	0.010	0.020	0.030	0.040	0.049	0.099	0.198	0.395	2057	4.45
36	0.020	0.040	0.060	0.080	0.099	0.199	0.398		1429	4.58
42	0.036	0.073	0.109	0.146	0.182	0.364			1050	4.64
48	0.062	0.124	0.185	0.247	0.309				804	4.66
54	0.098	0.196	0.294	0.393	0.491				635	4.7
60	0.149	0.298	0.447						514	4.72
66	0.217	0.434							425	4.74
72	0.306	0.612							357	4.76

Properties Per Foot of Width	# of Bars	Load Bar Depth	Bar Centers	Weight/sq ft
A = 4.07 in <sup>2</sup>   I = 0.90 in <sup>4</sup>   S = 1.20 in <sup>3</sup>	15	1.5"	0.78"	3.74

**I 30-40-ADA**  
**I Bearing Bar**  
 3" Thick  
 40% Open

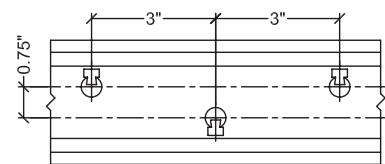
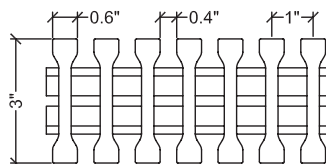
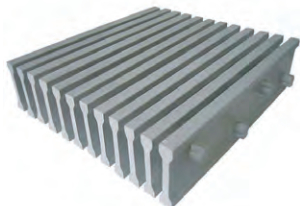

Span (inches)	CONCENTRATED LOAD in lb/ft of width								Max Load (lb/ft)	Apparent EI x 10 <sup>6</sup> (lb-in <sup>2</sup> )
	50	100	150	200	250	500	1000	2000		
12	<0.001	<0.001	<0.001	<0.001	<0.001	0.001	0.003	0.006	59580	12.45
18	<0.001	<0.001	<0.001	0.001	0.002	0.003	0.006	0.012	39720	19.96
24	<0.001	0.001	0.002	0.002	0.003	0.005	0.011	0.021	29790	26.81
30	<0.001	0.002	0.003	0.003	0.004	0.009	0.017	0.034	23832	32.86
36	0.001	0.003	0.004	0.005	0.006	0.013	0.026	0.051	19860	37.90
42	0.002	0.004	0.006	0.007	0.009	0.018	0.037	0.073	17023	42.09
48	0.003	0.005	0.008	0.010	0.013	0.025	0.051	0.101	14895	45.51
54	0.003	0.007	0.010	0.014	0.017	0.034	0.068	0.136	13240	48.27
60	0.004	0.009	0.013	0.018	0.022	0.045	0.090	0.179	11916	50.22
66	0.006	0.012	0.017	0.023	0.029	0.058	0.116	0.232	10833	51.62
72	0.007	0.015	0.022	0.030	0.037	0.074	0.148	0.296	9930	52.62

Span (inches)	UNIFORM LOAD in lb/ft <sup>2</sup>								Max Load (lb/ft <sup>2</sup> )	Apparent EI x 10 <sup>6</sup> (lb-in <sup>2</sup> )
	50	100	150	200	250	500	1000	2000		
12	<0.001	<0.001	<0.001	<0.001	<0.001	0.001	0.002	0.004	76262	12.45
18	<0.001	<0.001	<0.001	0.001	0.001	0.003	0.006	0.011	33894	19.96
24	<0.001	0.001	0.002	0.003	0.003	0.007	0.013	0.027	19066	26.81
30	0.001	0.003	0.004	0.005	0.007	0.013	0.027	0.053	12202	32.86
36	0.002	0.005	0.007	0.010	0.012	0.024	0.048	0.096	8474	37.9
42	0.004	0.008	0.012	0.016	0.020	0.040	0.080	0.160	6226	42.09
48	0.006	0.013	0.019	0.025	0.032	0.063	0.127	0.253	4766	45.51
54	0.010	0.019	0.029	0.038	0.048	0.096	0.191	0.382	3766	48.27
60	0.014	0.028	0.042	0.056	0.070	0.140	0.280	0.560	3050	50.22
66	0.020	0.040	0.060	0.080	0.100	0.199	0.399		2521	51.62
72	0.028	0.055	0.083	0.111	0.139	0.277	0.554		2118	52.62

Properties Per Foot of Width	# of Bars	Load Bar Depth	Bar Centers	Weight/sq ft
A = 14.44 in <sup>2</sup>   I = 13.76 in <sup>4</sup>   S = 9.18 in <sup>3</sup>	12	3"	1"	12.28



**I 30-50**  
**I Bearing Bar**  
**3" Thick**  
**50% Open**

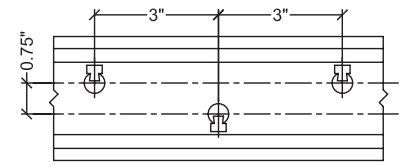
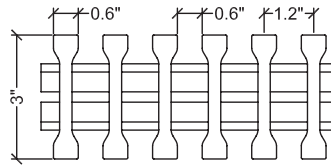
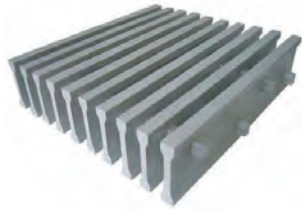

Span (inches)	CONCENTRATED LOAD in lb/ft of width								Max Load (lb/ft)	Apparent EI x 10 <sup>6</sup> (lb-in <sup>2</sup> )
	50	100	150	200	250	500	1000	2000		
12	<0.001	<0.001	<0.001	<0.001	0.001	0.002	0.004	0.008	46720	8.56
18	<0.001	<0.001	0.001	0.002	0.002	0.004	0.008	0.016	31147	15.02
24	<0.001	0.001	0.002	0.003	0.003	0.007	0.014	0.027	23360	21.12
30	0.001	0.002	0.003	0.004	0.005	0.010	0.021	0.042	18688	26.84
36	0.002	0.003	0.005	0.006	0.008	0.015	0.030	0.060	15573	32.25
42	0.002	0.004	0.006	0.008	0.011	0.021	0.042	0.084	13349	36.75
48	0.003	0.006	0.009	0.011	0.014	0.029	0.057	0.115	11680	40.14
54	0.004	0.008	0.011	0.015	0.019	0.038	0.076	0.153	10382	43.00
60	0.005	0.010	0.015	0.020	0.025	0.050	0.100	0.201	9344	44.86
66	0.007	0.013	0.020	0.026	0.033	0.065	0.130	0.260	8495	46.00
72	0.008	0.017	0.025	0.033	0.041	0.083	0.165	0.331	7787	47.00

Span (inches)	UNIFORM LOAD in lb/ft <sup>2</sup>								Max Load (lb/ft <sup>2</sup> )	Apparent EI x 10 <sup>6</sup> (lb-in <sup>2</sup> )
	50	100	150	200	250	500	1000	2000		
12	<0.001	<0.001	<0.001	<0.001	<0.001	0.001	0.003	0.005	59802	8.56
18	<0.001	<0.001	0.001	0.002	0.002	0.004	0.008	0.015	26578	15.02
24	<0.001	0.002	0.003	0.003	0.004	0.009	0.017	0.034	14950	21.12
30	0.002	0.003	0.005	0.007	0.008	0.016	0.033	0.065	9568	26.84
36	0.003	0.006	0.008	0.011	0.014	0.028	0.057	0.113	6645	32.25
42	0.005	0.009	0.014	0.018	0.023	0.046	0.092	0.184	4882	36.75
48	0.007	0.014	0.022	0.029	0.036	0.072	0.143	0.287	3738	40.14
54	0.011	0.021	0.032	0.043	0.054	0.107	0.215	0.429	2953	43.00
60	0.016	0.031	0.047	0.063	0.078	0.157	0.313	0.627	2392	44.86
66	0.022	0.045	0.067	0.090	0.112	0.224	0.448		1977	46.00
72	0.031	0.062	0.093	0.124	0.155	0.310	0.620		1661	47.00

Properties Per Foot of Width	# of Bars	Load Bar Depth	Bar Centers	Weight/sq ft
A = 12.04 in <sup>2</sup> I = 11.47 in <sup>4</sup> S = 7.65 in <sup>3</sup>	10	3"	1.2"	10.34

**I 30-60**  
**I Bearing Bar**  
**3" Thick**  
**60% Open**

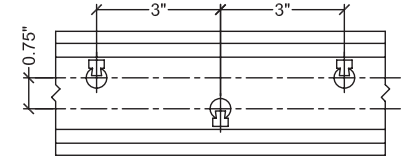
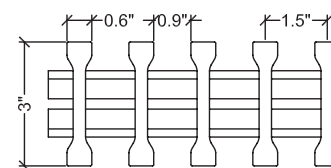
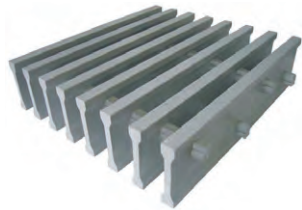

Span (inches)	CONCENTRATED LOAD in lb/ft of width								Max Load (lb/ft)	Apparent EI x 10 <sup>6</sup> (lb-in <sup>2</sup> )
	50	100	150	200	250	500	1000	2000		
12	<0.001	<0.001	<0.001	0.001	0.001	0.003	0.005	0.011	34635	6.85
18	<0.001	0.001	0.002	0.002	0.003	0.005	0.010	0.021	23090	11.68
24	<0.001	0.002	0.003	0.003	0.004	0.009	0.017	0.035	17318	16.68
30	0.001	0.003	0.004	0.005	0.007	0.014	0.027	0.054	13854	20.78
36	0.002	0.004	0.006	0.008	0.010	0.019	0.039	0.077	11545	25.24
42	0.003	0.005	0.008	0.010	0.013	0.026	0.052	0.105	9896	29.42
48	0.004	0.007	0.011	0.014	0.018	0.035	0.070	0.141	8659	32.70
54	0.005	0.009	0.014	0.019	0.023	0.047	0.094	0.187	7697	35.00
60	0.006	0.012	0.019	0.025	0.031	0.062	0.124	0.248	6927	36.30
66	0.008	0.016	0.024	0.032	0.040	0.080	0.160	0.320	6297	37.40
72	0.010	0.020	0.030	0.041	0.051	0.102	0.203	0.406	5773	38.30

Span (inches)	UNIFORM LOAD in lb/ft <sup>2</sup>								Max Load (lb/ft <sup>2</sup> )	Apparent EI x 10 <sup>6</sup> (lb-in <sup>2</sup> )
	50	100	150	200	250	500	1000	2000		
12	<0.001	<0.001	<0.001	<0.001	<0.001	0.002	0.003	0.007	44333	6.85
18	<0.001	0.001	0.001	0.002	0.002	0.005	0.010	0.020	19703	11.68
24	0.001	0.002	0.003	0.004	0.005	0.011	0.022	0.043	11083	16.68
30	0.002	0.004	0.006	0.008	0.011	0.021	0.042	0.085	7093	20.78
36	0.004	0.007	0.011	0.014	0.018	0.036	0.072	0.144	4926	25.24
42	0.006	0.011	0.017	0.023	0.029	0.057	0.115	0.230	3619	29.42
48	0.009	0.018	0.026	0.035	0.044	0.088	0.176	0.352	2771	32.70
54	0.013	0.026	0.040	0.053	0.066	0.132	0.264	0.527	2189	35.00
60	0.019	0.039	0.058	0.077	0.097	0.194	0.387		1773	36.30
66	0.028	0.055	0.083	0.110	0.138	0.275	0.551		1466	37.40
72	0.038	0.076	0.114	0.152	0.190	0.381			1231	38.30

Properties Per Foot of Width	# of Bars	Load Bar Depth	Bar Centers	Weight/sq ft
A = 9.63 in <sup>2</sup> I = 9.18 in <sup>4</sup> S = 6.12 in <sup>3</sup>	8	3"	1.5"	8.40

# PROGrate® Heavy Duty Pultruded Grating (HDP)



**NOTE:** These products are only available by special order. Minimum orders, extended lead times and special-order pricing will apply. PROGrate® Heavy Duty Pultruded (HDP) grating is engineered to carry higher loads than traditional grating. It also delivers the same high-strength, corrosion-resistant performance as our PROGrate® pultruded grating products. PROGrate® HDP grating is available by special order in 1", 1½", 2" and 2½" thicknesses and gray IFR and VFR resin systems. Made-to-order panels are available up to 5' wide by 20' long.

### Available Resin Systems

PROGrate® HDP grating is available in two resin systems, each providing different levels of corrosion protection. Both resin systems meet Class 1 Flame Spread Rating per ASTM E-84 test standards.

**IFR:** A premium-grade isophthalic polyester resin system that provides excellent corrosion protection.





**VFR:** A vinyl ester resin system that provides the highest level of corrosion protection.

### APPLICATIONS

- Flooring, platforms and ramps
- Storage areas
- Assembly lines
- Long-span walkways
- Trench covers with vehicular traffic

### FEATURES

- High strength
- Corrosion resistant
- Low conductivity
- Fire retardant
- Low maintenance

Allowable Spans for Vehicular Loads	Wheel Load (lb) (½ Axle Load + 30% Impact)	Load Distribution Parallel to Axle (in)	Allowable Span in Inches								
			HDP 15-40	HDP 15-50	HDP 15-60	HDP 20-40	HDP 20-50	HDP 20-60	HDP 25-40	HDP 25-50	HDP 25-60
 <b>AASHTO Standard Truck<sup>4</sup></b> 32,000 lb Axle Load - Dual Wheels (*formerly AASHTO H-20)	20,800	20	17	14	12	23	22	20	29	27	26
 <b>Automobile Traffic</b> 5,000 lb Vehicle - 1,500 lb Load 55% Drive Axle Load	2,220	8	28	27	26	37	36	35	47	45	43
 <b>5 Ton Capacity Forklift</b> 14,400 lb Vehicle - 1,500 lb Total Load 85% Drive Axle Load	13,480	11	15	14	12	22	22	20	28	27	25
 <b>3 Ton Capacity Forklift</b> 9,800 lb Vehicle - 1,500 lb Total Load 85% Drive Axle Load	8,730	7	16	14	12	23	22	21	28	27	26
 <b>1 Ton Capacity Forklift</b> 4,200 lb Vehicle - 6,200 lb Total Load 85% Drive Axle Load	3,425	4	20	20	19	27	27	25	34	34	32

**NOTES: Allowable Spans for Vehicular Loads**

1. Load is carried by the grating load bars immediately under wheel + two additional load bars.
2. Allowable span is based on allowable bending stress and 0.25" deflection; other criteria may be required by certain construction codes. Check code requirements to determine design criteria.

3. ALLOWABLE SPAN IS STRONGLY DEPENDENT ON WHEEL WIDTH AND VEHICLE LOAD CAPACITY. If your application varies from the values shown on this table, contact us for assistance.
4. Load based on AASHTO LRFD bridge design Specification, 2 Ed. This does not imply that the allowable span meets the deflection requirements of this specification.

# PROGrate® Heavy Duty Pultruded Grating Load and Deflection Data

## CONCENTRATED LOAD

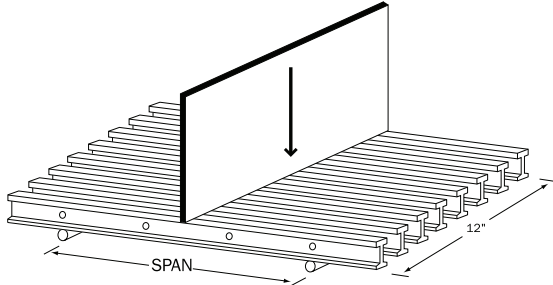

## UNIFORM LOAD

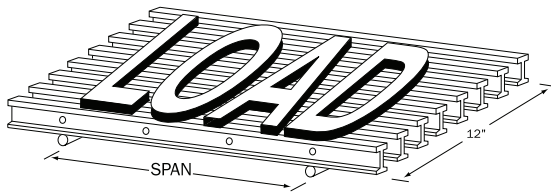

1. The following tables were developed in accordance with the test method developed by the Fiberglass Grating Manufacturers Council (FGMC) of the American Composites Manufacturers Association (ACMA) for the Fiberglass Grating Standard.
2. The designer should not exceed **MAXIMUM RECOMMENDED** load at any time. **ULTIMATE CAPACITY** represents **MAX LOAD** observed at initial fracture.
3. Walking loads for maintenance traffic are typically a live load of 50 PSF. Deflections for worker comfort are typically limited to 0.375" (3/8") or SPAN divided by 120 under full live load. For a firmer feel under full live load or a line load 250 lb/ft of width, limit deflections to 0.25" (1/4") or SPAN divided by 200.
4. The loads represented are for **STATIC LOAD CONDITIONS** at ambient temperature. Deflections for impact loads or dynamic loads will **MULTIPLY** the deflections shown by 2. Long term loads will result in added deflection due to creep in the material and will require higher factors of safety to ensure acceptable performance.
5. Deflections are limited to 0.5" (1/2") as recommended by the Fiberglass Grating Manufacturers Council of the American Composites Manufacturers Association.

**HD 10-40**  
**HD Bearing Bar**  
 1" Thick  
 40% Open

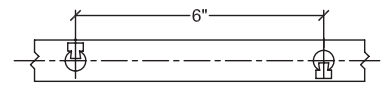
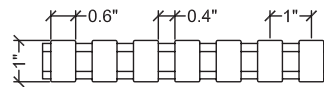
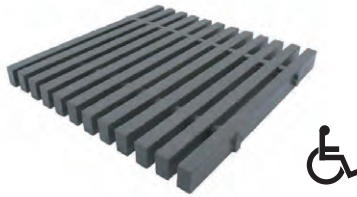

Span (inches)	CONCENTRATED LOAD in lb/ft of width								Max Load (lb/ft)	Apparent EI x 10 <sup>6</sup> (lb-in <sup>2</sup> )
	50	100	150	200	250	500	1000	2000		
12	0.002	0.003	0.005	0.007	0.008	0.017	0.034	0.068	11275	1.06
18	0.003	0.007	0.010	0.013	0.016	0.033	0.065	0.130	7517	1.87
24	0.006	0.012	0.018	0.024	0.030	0.059	0.118	0.236	5637	2.44
30	0.010	0.020	0.030	0.040	0.050	0.101	0.201	0.403	4510	2.79
36	0.016	0.033	0.049	0.065	0.081	0.163	0.326	0.652	3758	2.98
42	0.025	0.050	0.075	0.100	0.125	0.249	0.498		3221	3.10
48	0.037	0.073	0.110	0.146	0.183	0.366			2819	3.15
54	0.052	0.103	0.155	0.206	0.258	0.516			2506	3.18
60	0.070	0.141	0.211	0.281	0.352				2255	3.20

Span (inches)	UNIFORM LOAD in lb/ft <sup>2</sup>								Max Load (lb/ft <sup>2</sup> )	Apparent EI x 10 <sup>6</sup> (lb-in <sup>2</sup> )
	50	100	150	200	250	500	1000	2000		
12	0.001	0.002	0.003	0.004	0.005	0.011	0.021	0.042	9020	1.06
18	0.003	0.006	0.009	0.012	0.015	0.030	0.061	0.122	6013	1.87
24	0.007	0.015	0.022	0.030	0.037	0.074	0.148	0.295	4510	2.44
30	0.016	0.031	0.047	0.063	0.079	0.157	0.315	0.629	3608	2.79
36	0.031	0.061	0.092	0.122	0.153	0.306	0.611		2506	2.98
42	0.054	0.109	0.163	0.218	0.272	0.545			1841	3.10
48	0.091	0.183	0.274	0.366	0.457				1409	3.15
54	0.145	0.290	0.435	0.580					1114	3.18
60	0.220	0.439	0.659						902	3.20

Properties Per Foot of Width	# of Bars	Load Bar Depth	Bar Centers	Weight/sq ft
A = 7.20 in <sup>2</sup> I = 0.60 in <sup>4</sup> S = 1.20 in <sup>3</sup>	12	1"	1"	5.84





**HD 10-50**  
**HD Bearing Bar**  
 1" Thick  
 50% Open

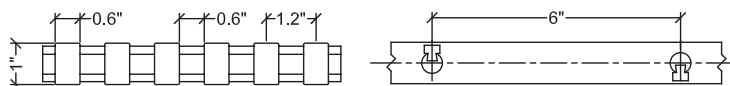

Span (inches)	CONCENTRATED LOAD in lb/ft of width								Max Load (lb/ft)	Apparent EI x 10 <sup>6</sup> (lb-in <sup>2</sup> )
	50	100	150	200	250	500	1000	2000		
12	0.002	0.004	0.006	0.008	0.010	0.020	0.040	0.080	9318	0.90
18	0.004	0.007	0.011	0.014	0.018	0.036	0.072	0.144	6216	1.69
24	0.007	0.013	0.020	0.026	0.033	0.066	0.132	0.264	4659	2.18
30	0.012	0.023	0.035	0.046	0.058	0.116	0.232	0.465	3727	2.42
36	0.019	0.038	0.057	0.076	0.095	0.190	0.380		3106	2.56
42	0.030	0.059	0.089	0.119	0.148	0.297	0.594		2662	2.60
48	0.044	0.088	0.131	0.175	0.219	0.438			2330	2.63
54	0.062	0.124	0.186	0.248	0.309	0.619			2071	2.65
60	0.084	0.169	0.253	0.337	0.421				1864	2.67

Span (inches)	UNIFORM LOAD in lb/ft <sup>2</sup>								Max Load (lb/ft <sup>2</sup> )	Apparent EI x 10 <sup>6</sup> (lb-in <sup>2</sup> )
	50	100	150	200	250	500	1000	2000		
12	0.001	0.002	0.004	0.005	0.006	0.012	0.025	0.050	7455	0.90
18	0.003	0.007	0.010	0.013	0.017	0.034	0.067	0.135	4970	1.69
24	0.008	0.017	0.025	0.033	0.041	0.083	0.165	0.330	3727	2.18
30	0.018	0.036	0.054	0.073	0.091	0.182	0.363		2982	2.42
36	0.036	0.071	0.107	0.142	0.178	0.356			2071	2.56
42	0.065	0.130	0.195	0.260	0.325	0.649			1521	2.60
48	0.109	0.219	0.328	0.438	0.547				1165	2.63
54	0.174	0.348	0.522	0.696					920	2.65
60	0.263	0.527							745	2.67

Properties Per Foot of Width	# of Bars	Load Bar Depth	Bar Centers	Weight/sq ft
A = 6.00 in <sup>2</sup> I = 0.50 in <sup>4</sup> S = 1.00 in <sup>3</sup>	10	1"	1.2"	4.94

**HD 10-60**  
**HD Bearing Bar**  
 1" Thick  
 60% Open

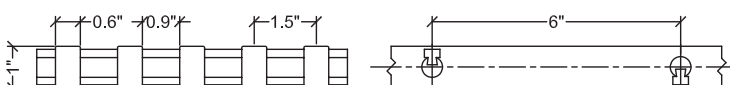

Span (inches)	CONCENTRATED LOAD in lb/ft of width								Max Load (lb/ft)	Apparent EI x 10 <sup>6</sup> (lb-in <sup>2</sup> )
	50	100	150	200	250	500	1000	2000		
12	0.003	0.005	0.008	0.010	0.013	0.025	0.050	0.100	7548	0.72
18	0.004	0.009	0.013	0.017	0.021	0.043	0.086	0.171	5032	1.42
24	0.008	0.016	0.024	0.032	0.040	0.079	0.158	0.316	3774	1.82
30	0.014	0.028	0.043	0.057	0.071	0.142	0.284	0.568	3019	1.98
36	0.023	0.046	0.069	0.093	0.116	0.231	0.463		2516	2.10
42	0.036	0.072	0.108	0.144	0.180	0.361			2156	2.14
48	0.053	0.107	0.160	0.213	0.267	0.533			1887	2.16
54	0.075	0.150	0.225	0.300	0.374				1677	2.19
60	0.102	0.205	0.307	0.409	0.511				1510	2.20

Span (inches)	UNIFORM LOAD in lb/ft <sup>2</sup>								Max Load (lb/ft <sup>2</sup> )	Apparent EI x 10 <sup>6</sup> (lb-in <sup>2</sup> )
	50	100	150	200	250	500	1000	2000		
12	0.002	0.003	0.005	0.006	0.008	0.016	0.031	0.062	6037	0.72
18	0.004	0.008	0.012	0.016	0.020	0.040	0.080	0.160	4025	1.42
24	0.010	0.020	0.030	0.040	0.049	0.099	0.198	0.396	3018	1.82
30	0.022	0.044	0.067	0.089	0.111	0.222	0.444		2415	1.98
36	0.043	0.087	0.130	0.174	0.217	0.434			1677	2.10
42	0.079	0.158	0.237	0.316	0.394				1232	2.14
48	0.133	0.267	0.400	0.533	0.667				943	2.16
54	0.211	0.421	0.632						745	2.19
60	0.320	0.639							604	2.20

Properties Per Foot of Width	# of Bars	Load Bar Depth	Bar Centers	Weight/sq ft
A = 4.80 in <sup>2</sup> I = 0.40 in <sup>4</sup> S = 0.80 in <sup>3</sup>	8	1"	1.5"	4.05

**HD 15-40**  
**HD Bearing Bar**  
 1½" Thick  
 40% Open

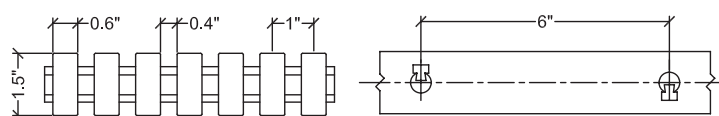

Span (inches)	CONCENTRATED LOAD in lb/ft of width								Max Load (lb/ft)	Apparent EI x 10 <sup>6</sup> (lb-in <sup>2</sup> )
	50	100	150	200	250	500	1000	2000		
12	<0.001	<0.001	0.001	0.001	0.002	0.003	0.007	0.013	25696	5.40
18	<0.001	0.001	0.002	0.003	0.003	0.007	0.014	0.027	17130	8.84
24	0.001	0.003	0.004	0.005	0.007	0.014	0.027	0.055	12848	10.56
30	0.003	0.005	0.008	0.010	0.013	0.025	0.050	0.101	10278	11.17
36	0.004	0.008	0.013	0.017	0.021	0.042	0.084	0.168	8565	11.55
42	0.007	0.013	0.020	0.026	0.033	0.066	0.131	0.262	7342	11.78
48	0.010	0.019	0.029	0.038	0.048	0.095	0.191	0.381	6424	12.09
54	0.013	0.027	0.040	0.054	0.067	0.134	0.268	0.536	5710	12.25
60	0.018	0.036	0.054	0.072	0.090	0.181	0.362		5139	12.43
66	0.024	0.048	0.072	0.096	0.120	0.240	0.480		4672	12.49
72	0.031	0.062	0.093	0.124	0.155	0.311	0.621		4283	12.52

Span (inches)	UNIFORM LOAD in lb/ft <sup>2</sup>								Max Load (lb/ft <sup>2</sup> )	Apparent EI x 10 <sup>6</sup> (lb-in <sup>2</sup> )
	50	100	150	200	250	500	1000	2000		
12	<0.001	<0.001	<0.001	<0.001	0.001	0.002	0.004	0.008	29744	5.40
18	<0.001	0.001	0.002	0.003	0.003	0.006	0.013	0.026	19830	8.84
24	0.002	0.003	0.005	0.007	0.009	0.017	0.034	0.068	14872	10.56
30	0.004	0.008	0.012	0.016	0.020	0.039	0.079	0.157	11898	11.17
36	0.008	0.016	0.024	0.032	0.039	0.079	0.158	0.316	8362	11.55
42	0.014	0.029	0.043	0.057	0.072	0.143	0.287	0.573	6070	11.78
48	0.024	0.048	0.071	0.095	0.119	0.238	0.477		4648	12.09
54	0.038	0.075	0.113	0.151	0.188	0.377			3672	12.25
60	0.057	0.113	0.170	0.226	0.283	0.565			2974	12.43
66	0.082	0.165	0.247	0.330	0.412				2458	12.49
72	0.116	0.233	0.349	0.466	0.582				2066	12.52

Properties Per Foot of Width	# of Bars	Load Bar Depth	Bar Centers	Weight/sq ft
A = 10.80 in <sup>2</sup> I = 2.03 in <sup>4</sup> S = 2.71 in <sup>3</sup>	12	1.5"	1"	9.13

**HD 15-50**  
**HD Bearing Bar**  
 1½" Thick  
 50% Open

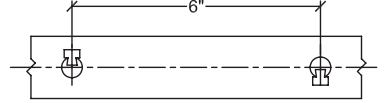
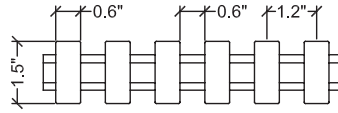

Span (inches)	CONCENTRATED LOAD in lb/ft of width								Max Load (lb/ft)	Apparent EI x 10 <sup>6</sup> (lb-in <sup>2</sup> )
	50	100	150	200	250	500	1000	2000		
12	<0.001	0.001	0.002	0.002	0.003	0.006	0.011	0.022	21776	3.27
18	<0.001	0.002	0.003	0.003	0.004	0.009	0.017	0.035	14517	6.94
24	0.002	0.003	0.005	0.007	0.008	0.017	0.033	0.066	10888	8.71
30	0.003	0.006	0.009	0.012	0.015	0.031	0.061	0.122	8710	9.22
36	0.005	0.010	0.015	0.020	0.025	0.051	0.102	0.204	7259	9.53
42	0.008	0.016	0.024	0.032	0.040	0.079	0.159	0.318	6222	9.72
48	0.012	0.023	0.035	0.046	0.058	0.116	0.231	0.462	5444	9.97
54	0.016	0.032	0.049	0.065	0.081	0.162	0.325	0.649	4839	10.11
60	0.022	0.044	0.066	0.088	0.110	0.219	0.439		4355	10.26
66	0.029	0.058	0.087	0.116	0.145	0.291	0.581		3959	10.30
72	0.038	0.075	0.113	0.151	0.188	0.376			3629	10.33

Span (inches)	UNIFORM LOAD in lb/ft <sup>2</sup>								Max Load (lb/ft <sup>2</sup> )	Apparent EI x 10 <sup>6</sup> (lb-in <sup>2</sup> )
	50	100	150	200	250	500	1000	2000		
12	<0.001	<0.001	0.001	0.001	0.002	0.003	0.007	0.014	23452	3.27
18	<0.001	0.002	0.002	0.003	0.004	0.008	0.016	0.033	15635	6.94
24	0.002	0.004	0.006	0.008	0.010	0.021	0.041	0.083	11726	8.71
30	0.005	0.010	0.014	0.019	0.024	0.048	0.095	0.191	9381	9.22
36	0.010	0.019	0.029	0.038	0.048	0.096	0.191	0.382	6514	9.53
42	0.017	0.035	0.052	0.069	0.087	0.174	0.347	0.695	4786	9.72
48	0.029	0.058	0.087	0.115	0.144	0.289	0.577		3664	9.97
54	0.046	0.091	0.137	0.183	0.228	0.456			2895	10.11
60	0.069	0.137	0.206	0.274	0.343	0.685			2345	10.26
66	0.100	0.200	0.300	0.400	0.499				1938	10.30
72	0.141	0.282	0.424	0.565					1629	10.33

Properties Per Foot of Width	# of Bars	Load Bar Depth	Bar Centers	Weight/sq ft
A = 9.00 in <sup>2</sup> I = 1.60 in <sup>4</sup> S = 2.25 in <sup>3</sup>	10	1.5"	1.2"	7.69

**HD 15-60**  
**HD Bearing Bar**  
 1½" Thick  
 60% Open

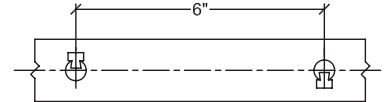
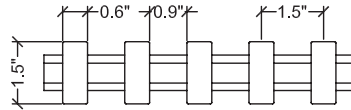

Span (inches)	CONCENTRATED LOAD in lb/ft of width								Max Load (lb/ft)	Apparent EI x 10 <sup>6</sup> (lb-in <sup>2</sup> )
	50	100	150	200	250	500	1000	2000		
12	<0.001	0.002	0.002	0.003	0.004	0.008	0.015	0.030	17720	2.40
18	0.001	0.002	0.003	0.004	0.006	0.011	0.022	0.044	11813	5.50
24	0.002	0.004	0.006	0.008	0.010	0.021	0.042	0.083	8860	6.90
30	0.004	0.008	0.012	0.015	0.019	0.039	0.077	0.154	7088	7.30
36	0.006	0.013	0.019	0.026	0.032	0.064	0.129	0.257	5907	7.55
42	0.010	0.020	0.030	0.040	0.050	0.100	0.200	0.401	5063	7.70
48	0.015	0.029	0.044	0.058	0.073	0.146	0.292	0.583	4430	7.90
54	0.020	0.041	0.061	0.082	0.102	0.205	0.410		3938	8.01
60	0.028	0.055	0.083	0.111	0.138	0.277	0.554		3544	8.13
66	0.037	0.073	0.110	0.147	0.183	0.367			3222	8.16
72	0.048	0.095	0.143	0.190	0.238	0.475			2953	8.18

Span (inches)	UNIFORM LOAD in lb/ft <sup>2</sup>								Max Load (lb/ft <sup>2</sup> )	Apparent EI x 10 <sup>6</sup> (lb-in <sup>2</sup> )
	50	100	150	200	250	500	1000	2000		
12	<0.001	<0.001	0.001	0.002	0.002	0.005	0.009	0.019	18763	2.40
18	0.001	0.002	0.003	0.004	0.005	0.010	0.021	0.041	12509	5.50
24	0.003	0.005	0.008	0.010	0.013	0.026	0.052	0.104	9382	6.90
30	0.006	0.012	0.018	0.024	0.030	0.060	0.120	0.241	7505	7.30
36	0.012	0.024	0.036	0.048	0.060	0.121	0.241	0.483	5212	7.55
42	0.022	0.044	0.066	0.088	0.110	0.219	0.438		3829	7.70
48	0.036	0.073	0.109	0.146	0.182	0.365			2932	7.90
54	0.058	0.115	0.173	0.230	0.288	0.576			2317	8.01
60	0.087	0.173	0.260	0.346	0.433				1878	8.13
66	0.126	0.252	0.378	0.504	0.631				1551	8.16
72	0.178	0.356	0.535	0.713					1303	8.18

Properties Per Foot of Width	# of Bars	Load Bar Depth	Bar Centers	Weight/sq ft
A = 7.20 in <sup>2</sup> I = 1.36 in <sup>4</sup> S = 1.81 in <sup>3</sup>	8	1.5"	1.5"	6.25

**HD 20-40  
HD Bearing Bar  
2" Thick  
40% Open**

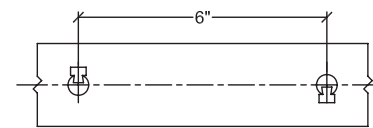
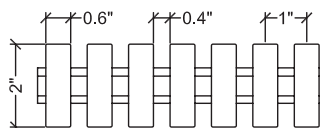

Span (inches)	CONCENTRATED LOAD in lb/ft of width								Max Load (lb/ft)	Apparent EI x 10 <sup>6</sup> (lb-in <sup>2</sup> )
	50	100	150	200	250	500	1000	2000		
12	<0.001	<0.001	<0.001	0.001	0.001	0.003	0.005	0.010	48090	6.92
18	<0.001	<0.001	0.001	0.002	0.002	0.005	0.009	0.019	32060	12.80
24	<0.001	0.002	0.003	0.003	0.004	0.009	0.017	0.034	24045	16.80
30	0.001	0.003	0.004	0.006	0.007	0.014	0.029	0.058	19236	19.50
36	0.002	0.005	0.007	0.009	0.011	0.023	0.045	0.090	16030	21.60
42	0.003	0.007	0.010	0.013	0.017	0.034	0.067	0.134	13740	23.00
48	0.005	0.010	0.014	0.019	0.024	0.048	0.096	0.193	12023	23.90
54	0.007	0.013	0.020	0.027	0.034	0.067	0.135	0.270	10687	24.34
60	0.009	0.018	0.027	0.036	0.046	0.091	0.182	0.365	9618	24.69
66	0.012	0.024	0.036	0.048	0.060	0.120	0.240	0.479	8744	25.00
72	0.015	0.031	0.046	0.061	0.077	0.154	0.307	0.614	8015	25.33
78	0.019	0.039	0.058	0.078	0.097	0.195	0.389		7398	25.40
84	0.024	0.048	0.072	0.096	0.121	0.241	0.482		6870	25.60

Span (inches)	UNIFORM LOAD in lb/ft <sup>2</sup>								Max Load (lb/ft <sup>2</sup> )	Apparent EI x 10 <sup>6</sup> (lb-in <sup>2</sup> )
	50	100	150	200	250	500	1000	2000		
12	<0.001	<0.001	<0.001	<0.001	<0.001	0.002	0.003	0.007	24623	6.92
18	<0.001	<0.001	0.001	0.002	0.002	0.004	0.009	0.018	16415	12.80
24	0.001	0.002	0.003	0.004	0.005	0.011	0.021	0.043	12311	16.80
30	0.002	0.005	0.007	0.009	0.011	0.023	0.045	0.090	9849	19.50
36	0.004	0.008	0.013	0.017	0.021	0.042	0.084	0.169	6840	21.60
42	0.007	0.015	0.022	0.029	0.037	0.073	0.147	0.294	5025	23.00
48	0.012	0.024	0.036	0.048	0.060	0.120	0.241	0.482	3847	23.90
54	0.019	0.038	0.057	0.076	0.095	0.189	0.379		3040	24.34
60	0.028	0.057	0.085	0.114	0.142	0.285	0.570		2462	24.69
66	0.041	0.082	0.124	0.165	0.206	0.412			2035	25.00
72	0.058	0.115	0.173	0.230	0.288	0.576			1710	25.33
78	0.079	0.158	0.237	0.316	0.395				1457	25.40
84	0.106	0.211	0.317	0.422	0.528				1256	25.60

Properties Per Foot of Width	# of Bars	Load Bar Depth	Bar Centers	Weight/sq ft
A = 14.4 in <sup>2</sup>   I = 4.80 in <sup>4</sup>   S = 4.80 in <sup>3</sup>	12	2"	1"	11.81

**HD 20-50  
HD Bearing Bar  
2" Thick  
50% Open**

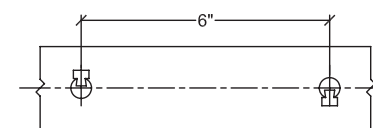
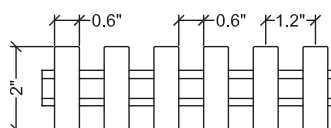

Span (inches)	CONCENTRATED LOAD in lb/ft of width								Max Load (lb/ft)	Apparent EI x 10 <sup>6</sup> (lb-in <sup>2</sup> )
	50	100	150	200	250	500	1000	2000		
12	<0.001	<0.001	0.001	0.001	0.002	0.004	0.007	0.014	43449	5.14
18	<0.001	0.001	0.002	0.003	0.003	0.007	0.013	0.027	28966	9.10
24	0.001	0.002	0.003	0.004	0.006	0.011	0.022	0.045	21725	12.90
30	0.002	0.003	0.005	0.007	0.009	0.017	0.035	0.069	17380	16.20
36	0.003	0.005	0.008	0.010	0.013	0.026	0.052	0.103	14483	18.83
42	0.004	0.008	0.012	0.015	0.019	0.038	0.077	0.154	12414	20.10
48	0.006	0.011	0.017	0.022	0.028	0.056	0.111	0.223	10862	20.67
54	0.008	0.016	0.024	0.032	0.039	0.079	0.158	0.315	9655	20.80
60	0.011	0.021	0.032	0.043	0.054	0.107	0.214	0.428	8690	21.02
66	0.014	0.028	0.043	0.057	0.071	0.142	0.284	0.569	7900	21.06
72	0.018	0.037	0.055	0.074	0.092	0.184	0.368		7142	21.12
78	0.023	0.047	0.070	0.093	0.117	0.233	0.466		6684	21.20
84	0.029	0.058	0.087	0.116	0.145	0.290	0.580		6207	21.30

Span (inches)	UNIFORM LOAD in lb/ft <sup>2</sup>								Max Load (lb/ft <sup>2</sup> )	Apparent EI x 10 <sup>6</sup> (lb-in <sup>2</sup> )
	50	100	150	200	250	500	1000	2000		
12	<0.001	<0.001	<0.001	<0.001	0.001	0.002	0.004	0.009	22248	5.14
18	<0.001	0.001	0.002	0.003	0.003	0.006	0.013	0.025	14832	9.10
24	0.001	0.003	0.004	0.006	0.007	0.014	0.028	0.056	11124	12.90
30	0.003	0.005	0.008	0.011	0.014	0.027	0.054	0.109	8899	16.20
36	0.005	0.010	0.015	0.019	0.024	0.048	0.097	0.194	6180	18.83
42	0.008	0.017	0.025	0.034	0.042	0.084	0.168	0.336	4540	20.10
48	0.014	0.028	0.042	0.056	0.070	0.139	0.279	0.557	3476	20.67
54	0.022	0.044	0.067	0.089	0.111	0.222	0.444		2747	20.80
60	0.033	0.067	0.100	0.134	0.167	0.334	0.669		2225	21.02
66	0.049	0.098	0.147	0.196	0.244	0.489			1839	21.06
72	0.069	0.138	0.207	0.276	0.345	0.690			1545	21.12
78	0.095	0.189	0.284	0.379	0.474				1316	21.20
84	0.127	0.254	0.380	0.507	0.634				1135	21.30

Properties Per Foot of Width	# of Bars	Load Bar Depth	Bar Centers	Weight/sq ft
A = 12.0 in <sup>2</sup>   I = 4.00 in <sup>4</sup>   S = 4.00 in <sup>3</sup>	10	2"	1.2"	9.92





**HD 20-60**  
**HD Bearing Bar**  
**2" Thick**  
**60% Open**

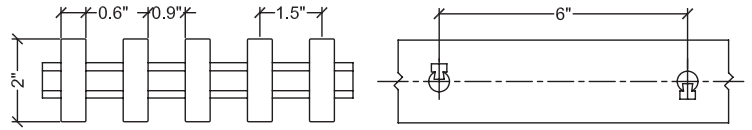

Span (inches)	CONCENTRATED LOAD in lb/ft of width								Max Load (lb/ft)	Apparent EI x 10 <sup>6</sup> (lb-in <sup>2</sup> )
	50	100	150	200	250	500	1000	2000		
12	<0.001	0.001	0.002	0.002	0.003	0.005	0.010	0.020	37380	3.56
18	<0.001	0.001	0.002	0.003	0.004	0.007	0.015	0.029	24920	8.30
24	0.001	0.002	0.004	0.005	0.006	0.012	0.023	0.047	18690	12.30
30	0.002	0.004	0.006	0.008	0.010	0.019	0.038	0.077	14952	14.70
36	0.003	0.006	0.009	0.012	0.015	0.030	0.060	0.119	12460	16.30
42	0.005	0.009	0.014	0.018	0.023	0.045	0.090	0.181	10680	17.10
48	0.007	0.013	0.020	0.026	0.033	0.065	0.131	0.262	9345	17.60
54	0.009	0.019	0.028	0.037	0.046	0.093	0.185	0.371	8307	17.70
60	0.013	0.025	0.038	0.051	0.063	0.127	0.253	0.506	7476	17.78
66	0.017	0.033	0.050	0.067	0.084	0.167	0.335	0.670	6796	17.88
72	0.022	0.043	0.065	0.086	0.108	0.216	0.432		6230	18.02
78	0.027	0.055	0.082	0.109	0.137	0.273	0.546		5751	18.10
84	0.034	0.068	0.102	0.136	0.170	0.339	0.678		5340	18.20

Span (inches)	UNIFORM LOAD in lb/ft <sup>2</sup>								Max Load (lb/ft <sup>2</sup> )	Apparent EI x 10 <sup>6</sup> (lb-in <sup>2</sup> )
	50	100	150	200	250	500	1000	2000		
12	<0.001	<0.001	<0.001	0.001	0.001	0.002	0.005	0.010	19140	4.56
18	<0.001	0.001	0.002	0.003	0.003	0.007	0.014	0.027	12760	8.34
24	0.001	0.003	0.004	0.006	0.007	0.014	0.028	0.057	9570	12.70
30	0.003	0.006	0.009	0.012	0.015	0.030	0.060	0.120	7656	14.70
36	0.006	0.011	0.017	0.022	0.028	0.056	0.112	0.224	5317	16.30
42	0.010	0.020	0.030	0.039	0.049	0.099	0.197	0.395	3906	17.10
48	0.016	0.033	0.049	0.065	0.082	0.164	0.327	0.655	2991	17.60
54	0.026	0.052	0.078	0.104	0.130	0.261	0.521		2363	17.70
60	0.040	0.079	0.119	0.158	0.198	0.395			1914	17.78
66	0.058	0.115	0.173	0.230	0.288	0.576			1582	17.88
72	0.081	0.162	0.243	0.324	0.405				1329	18.02
78	0.111	0.227	0.333	0.444	0.555				1133	18.10
84	0.148	0.292	0.445	0.594					977	18.20

Properties Per Foot of Width	# of Bars	Load Bar Depth	Bar Centers	Weight/sq ft
A = 9.60 in <sup>2</sup>   I = 3.20 in <sup>4</sup>   S = 3.20 in <sup>3</sup>	8	2"	1.5"	8.03

**HD 25-40**  
**HD Bearing Bar**  
**2½" Thick**  
**40% Open**

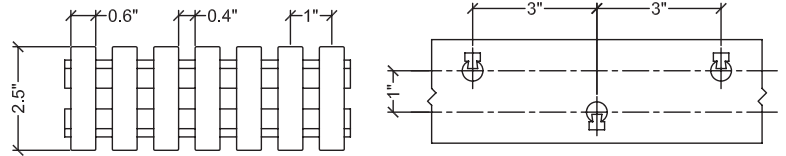

Span (inches)	CONCENTRATED LOAD in lb/ft of width								Max Load (lb/ft)	Apparent EI x 10 <sup>6</sup> (lb-in <sup>2</sup> )
	50	100	150	200	250	500	1000	2000		
12	<0.001	<0.001	<0.001	<0.001	0.001	0.002	0.004	0.008	68225	8.68
18	<0.001	<0.001	0.001	0.002	0.002	0.004	0.008	0.016	45483	15.20
24	<0.001	0.001	0.002	0.003	0.003	0.007	0.014	0.027	34113	21.00
30	0.001	0.002	0.003	0.004	0.005	0.010	0.021	0.042	27292	26.80
36	0.002	0.003	0.005	0.006	0.008	0.015	0.030	0.060	22742	32.20
42	0.002	0.004	0.006	0.009	0.011	0.021	0.043	0.086	19493	35.90
48	0.003	0.006	0.009	0.012	0.015	0.030	0.060	0.120	17056	38.40
54	0.004	0.008	0.012	0.016	0.020	0.041	0.081	0.162	15161	40.50
60	0.005	0.011	0.016	0.022	0.027	0.055	0.109	0.218	13645	41.20
66	0.007	0.014	0.021	0.029	0.036	0.071	0.143	0.286	12405	41.90
72	0.009	0.018	0.027	0.037	0.046	0.091	0.183	0.365	11371	42.60
78	0.012	0.023	0.035	0.046	0.058	0.115	0.231	0.461	10496	42.85
84	0.014	0.029	0.043	0.058	0.072	0.144	0.288	0.576	9746	42.90
90	0.018	0.035	0.053	0.071	0.088	0.177	0.353		9097	42.98
96	0.021	0.043	0.064	0.086	0.107	0.214	0.428		8528	43.10
102	0.026	0.051	0.077	0.102	0.128	0.256	0.512		8026	43.20

Span (inches)	UNIFORM LOAD in lb/ft <sup>2</sup>								Max Load (lb/ft <sup>2</sup> )	Apparent EI x 10 <sup>6</sup> (lb-in <sup>2</sup> )
	50	100	150	200	250	500	1000	2000		
12	<0.001	<0.001	<0.001	<0.001	<0.001	0.001	0.003	0.005	34933	8.56
18	<0.001	<0.001	0.001	0.001	0.002	0.004	0.007	0.015	23288	15.20
24	<0.001	0.002	0.003	0.003	0.004	0.009	0.017	0.034	17466	21.00
30	0.002	0.003	0.005	0.007	0.008	0.016	0.033	0.066	13973	26.80
36	0.003	0.006	0.008	0.011	0.014	0.028	0.057	0.113	9704	32.20
42	0.005	0.009	0.014	0.019	0.024	0.047	0.094	0.188	7129	35.90
48	0.008	0.015	0.023	0.030	0.038	0.075	0.150	0.300	5458	38.40
54	0.011	0.023	0.034	0.046	0.057	0.114	0.228	0.456	4313	40.50
60	0.017	0.034	0.051	0.068	0.085	0.171	0.341	0.683	3493	41.20
66	0.025	0.049	0.074	0.098	0.123	0.246	0.491		2887	41.90
72	0.034	0.068	0.103	0.137	0.171	0.342	0.684		2426	42.60
78	0.047	0.094	0.141	0.187	0.234	0.469			2067	42.85
84	0.063	0.126	0.189	0.252	0.315	0.630			1782	42.90
90	0.083	0.166	0.248	0.331	0.414				1553	42.98
96	0.107	0.214	0.321	0.428	0.535				1365	43.10
102	0.136	0.272	0.408	0.544	0.680				1209	43.20

Properties Per Foot of Width	# of Bars	Load Bar Depth	Bar Centers	Weight/sq ft
A = 18.00 in <sup>2</sup>   I = 9.38 in <sup>4</sup>   S = 7.50 in <sup>3</sup>	12	2.5"	1"	14.48

**HD 25-50**  
**HD Bearing Bar**  
 2½" Thick  
 50% Open

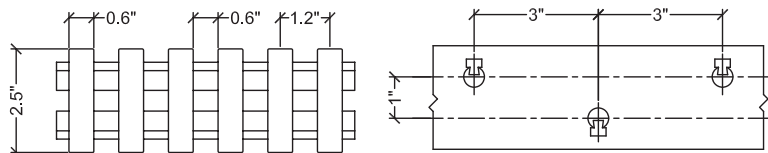

Span (inches)	CONCENTRATED LOAD in lb/ft of width								Max Load (lb/ft)	Apparent EI x 10 <sup>6</sup> (lb-in <sup>2</sup> )
	50	100	150	200	250	500	1000	2000		
12	<0.001	<0.001	<0.001	0.001	0.001	0.003	0.006	0.012	59525	6.02
18	<0.001	0.001	0.002	0.002	0.003	0.005	0.010	0.020	39683	12.03
24	<0.001	0.002	0.002	0.003	0.004	0.008	0.016	0.032	29763	18.20
30	0.001	0.002	0.003	0.005	0.006	0.011	0.023	0.046	23810	24.50
36	0.002	0.003	0.005	0.007	0.008	0.017	0.034	0.068	19842	28.80
42	0.002	0.005	0.007	0.010	0.012	0.025	0.049	0.099	17007	31.20
48	0.003	0.007	0.010	0.014	0.017	0.035	0.070	0.139	14881	33.10
54	0.005	0.010	0.014	0.019	0.024	0.048	0.095	0.190	13228	34.50
60	0.006	0.013	0.019	0.026	0.032	0.064	0.128	0.256	11905	35.10
66	0.008	0.017	0.025	0.034	0.042	0.084	0.168	0.336	10823	35.60
72	0.011	0.022	0.033	0.043	0.054	0.109	0.217	0.434	9921	35.80
78	0.014	0.027	0.041	0.055	0.069	0.137	0.275	0.549	9158	36.00
84	0.017	0.034	0.051	0.068	0.085	0.171	0.341	0.682	8504	36.20
90	0.021	0.042	0.063	0.083	0.104	0.209	0.417		7937	36.40
96	0.025	0.050	0.076	0.101	0.126	0.252	0.504		7441	36.60
102	0.030	0.060	0.090	0.120	0.150	0.300	0.601		7003	36.80

Span (inches)	UNIFORM LOAD in lb/ft <sup>2</sup>								Max Load (lb/ft <sup>2</sup> )	Apparent EI x 10 <sup>6</sup> (lb-in <sup>2</sup> )
	50	100	150	200	250	500	1000	2000		
12	<0.001	<0.001	<0.001	<0.001	<0.001	0.002	0.004	0.007	30480	6.02
18	<0.001	0.001	0.001	0.002	0.002	0.005	0.009	0.019	20320	12.03
24	0.001	0.002	0.003	0.004	0.005	0.010	0.020	0.040	15240	18.20
30	0.002	0.004	0.005	0.007	0.009	0.018	0.036	0.072	12192	24.50
36	0.003	0.006	0.009	0.013	0.016	0.032	0.063	0.127	8466	28.80
42	0.005	0.011	0.016	0.022	0.027	0.054	0.108	0.216	6220	31.20
48	0.009	0.017	0.026	0.035	0.044	0.087	0.174	0.348	4762	33.10
54	0.013	0.027	0.040	0.053	0.067	0.134	0.267	0.535	3763	34.50
60	0.020	0.040	0.060	0.080	0.100	0.200	0.401		3048	35.10
66	0.029	0.058	0.087	0.116	0.145	0.289	0.578		2519	35.60
72	0.041	0.081	0.122	0.163	0.204	0.407			2117	35.80
78	0.056	0.112	0.167	0.223	0.279	0.558			1803	36.00
84	0.075	0.149	0.224	0.298	0.373				1555	36.20
90	0.098	0.196	0.293	0.391	0.489				1355	36.40
96	0.126	0.252	0.378	0.504	0.629				1191	36.60
102	0.160	0.319	0.479	0.638					1055	36.80

Properties Per Foot of Width	# of Bars	Load Bar Depth	Bar Centers	Weight/sq ft
A = 15.0 in <sup>2</sup> I = 7.81 in <sup>4</sup> S = 6.25 in <sup>3</sup>	10	2.5"	1.2"	12.14

**HD 25-60**  
**HD Bearing Bar**  
 2½" Thick  
 60% Open

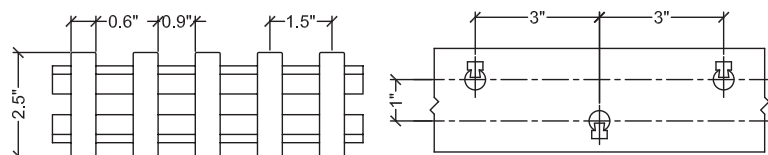

Span (inches)	CONCENTRATED LOAD in lb/ft of width								Max Load (lb/ft)	Apparent EI x 10 <sup>6</sup> (lb-in <sup>2</sup> )
	50	100	150	200	250	500	1000	2000		
12	<0.001	<0.001	0.001	0.001	0.002	0.003	0.007	0.014	41850	5.21
18	<0.001	0.001	0.002	0.002	0.003	0.006	0.012	0.025	27900	9.85
24	<0.001	0.002	0.003	0.004	0.005	0.010	0.020	0.040	20925	14.50
30	0.001	0.003	0.004	0.006	0.007	0.014	0.029	0.058	14740	19.50
36	0.002	0.004	0.006	0.008	0.010	0.021	0.042	0.084	13950	23.25
42	0.003	0.006	0.009	0.012	0.015	0.030	0.061	0.121	11957	25.50
48	0.004	0.009	0.013	0.017	0.022	0.043	0.087	0.174	10463	26.50
54	0.006	0.012	0.018	0.024	0.030	0.060	0.120	0.240	9300	27.30
60	0.008	0.016	0.025	0.033	0.041	0.082	0.164	0.327	8370	27.50
66	0.011	0.022	0.032	0.043	0.054	0.108	0.216	0.432	7609	27.70
72	0.014	0.028	0.042	0.056	0.070	0.139	0.279	0.557	6975	27.90
78	0.018	0.035	0.053	0.070	0.088	0.176	0.352		6438	28.10
84	0.022	0.044	0.065	0.087	0.109	0.218	0.436		5979	28.30
90	0.027	0.053	0.080	0.107	0.133	0.266	0.533		5580	28.50
96	0.032	0.064	0.096	0.128	0.161	0.321	0.642		5231	28.70
102	0.038	0.077	0.115	0.153	0.191	0.383			4924	28.90

Span (inches)	UNIFORM LOAD in lb/ft <sup>2</sup>								Max Load (lb/ft <sup>2</sup> )	Apparent EI x 10 <sup>6</sup> (lb-in <sup>2</sup> )
	50	100	150	200	250	500	1000	2000		
12	<0.001	<0.001	<0.001	<0.001	0.001	0.002	0.004	0.009	21428	5.21
18	<0.001	0.001	0.002	0.002	0.003	0.006	0.012	0.023	14285	9.85
24	0.001	0.002	0.003	0.004	0.005	0.010	0.020	0.040	10714	14.50
30	0.002	0.005	0.007	0.009	0.011	0.023	0.045	0.090	8571	19.50
36	0.004	0.008	0.012	0.016	0.020	0.039	0.078	0.157	5952	23.25
42	0.007	0.013	0.020	0.026	0.033	0.066	0.132	0.265	4373	25.50
48	0.011	0.022	0.033	0.043	0.054	0.109	0.217	0.435	3348	26.50
54	0.017	0.034	0.051	0.068	0.084	0.169	0.338	0.676	2646	27.30
60	0.026	0.051	0.077	0.102	0.128	0.256	0.511		2143	27.50
66	0.037	0.074	0.111	0.149	0.186	0.372			1771	27.70
72	0.052	0.105	0.157	0.209	0.261	0.523			1488	27.90
78	0.071	0.143	0.214	0.286	0.357				1268	28.10
84	0.095	0.191	0.286	0.382	0.477				1093	28.30
90	0.125	0.250	0.375	0.500	0.624				952	28.50
96	0.161	0.321	0.482	0.642					837	28.70
102	0.203	0.406	0.610						741	28.90

Properties Per Foot of Width	# of Bars	Load Bar Depth	Bar Centers	Weight/sq ft
A = 12.0 in <sup>2</sup> I = 6.25 in <sup>4</sup> S = 5.00 in <sup>3</sup>	8	2.5"	1.5"	9.81



## VGBA Certified Grating

**NOTE: These products are only available by special order. Minimum orders, extended lead times and special-order pricing will apply.**

Our PROGrate® pultruded FRP grating has been tested and has met the specifications set forth by the Virginia Graeme Baker Act (VGBA) for use in VGBA compliant drain systems.

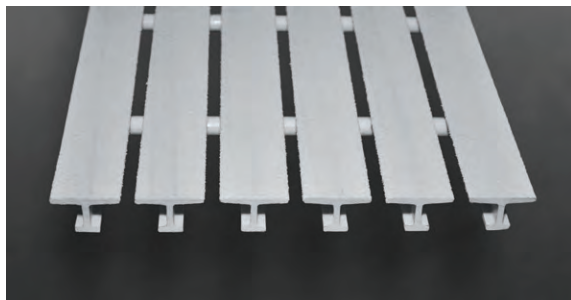

***PROGrate® I 10-40, I 15-40 and T 10-18 are ideal for fabricating VGBA-compliant drain systems around pools and spas.***

An independent test laboratory has tested PROGrate® pultruded grating in accordance with ASME A112.19.8.a – 2008, section 3.2 (Ultraviolet Light Exposure), which includes ASTM D256 for izod impact and ASTM D638 for tensile strength after being subjected to accelerated UV weathering.

Completed test results have shown that PROGrate® grating has a K factor of 1.1 when calculated from section 3.2.2.3 (Performance Requirements) of the ASME A112.19.8.a – 2008 specification, which is the test method for grating covering pool drains. Our grating products are available as stock panels or can be fabricated to size.



**I 10-40**  
**I Bearing Bar**  
**1" Thick**  
**40% Open**

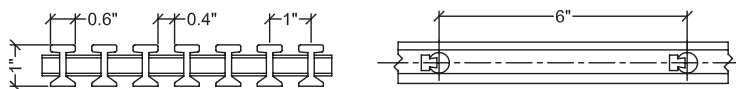

Span (inches)	CONCENTRATED LOAD in lb/ft of width								Max Load (lb/ft)	Apparent EI x 10 <sup>6</sup> (lb-in <sup>2</sup> )
	50	100	150	200	250	500	1000	2000		
12	0.001	0.002	0.003	0.004	0.005	0.011	0.021	0.042	8028	1.80
18	0.003	0.006	0.009	0.012	0.015	0.030	0.060	0.119	5352	2.10
24	0.006	0.013	0.019	0.025	0.032	0.063	0.126	0.253	4014	2.28
30	0.012	0.024	0.036	0.047	0.059	0.119	0.237	0.475	3211	2.37
36	0.020	0.040	0.060	0.080	0.100	0.201	0.402		2676	2.42
42	0.032	0.063	0.095	0.127	0.158	0.316	0.633		2294	2.44
48	0.047	0.094	0.141	0.188	0.235	0.470			2007	2.45
54	0.067	0.134	0.200	0.267	0.334	0.668			1784	2.46
60	0.091	0.182	0.273	0.364	0.455				1606	2.47
66	0.121	0.242	0.362	0.483	0.604				1460	2.48
72	0.156	0.312	0.468	0.625					1338	2.49

Span (inches)	UNIFORM LOAD in lb/ft <sup>2</sup>								Max Load (lb/ft <sup>2</sup> )	Apparent EI x 10 <sup>6</sup> (lb-in <sup>2</sup> )
	50	100	150	200	250	500	1000	2000		
12	0.001	0.001	0.002	0.002	0.003	0.006	0.012	0.025	17605	1.80
18	0.003	0.005	0.008	0.011	0.014	0.027	0.054	0.108	7969	2.10
24	0.008	0.016	0.024	0.032	0.039	0.079	0.158	0.316	3961	2.28
30	0.019	0.037	0.056	0.074	0.093	0.185	0.371		2574	2.37
36	0.038	0.075	0.113	0.151	0.188	0.377			1791	2.42
42	0.069	0.138	0.208	0.277	0.346	0.692			1314	2.44
48	0.118	0.235	0.353	0.470	0.588				1004	2.45
54	0.188	0.376	0.564						792	2.46
60	0.285	0.569							713	2.47

Properties Per Foot of Width	# of Bars	Load Bar Depth	Bar Centers	Weight/sq ft
A = 3.66 in <sup>2</sup> I = 0.46 in <sup>4</sup> S = 0.93 in <sup>3</sup>	12	1"	1"	3.47

**I 15-40**  
**I Bearing Bar**  
**1½" Thick**  
**40% Open**

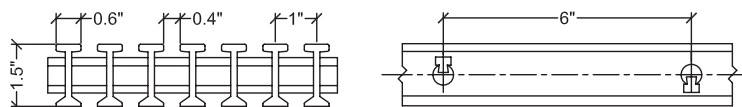
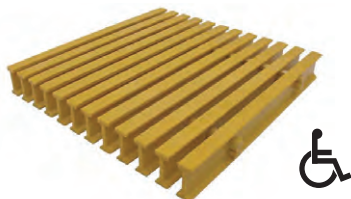

Span (inches)	CONCENTRATED LOAD in lb/ft of width								Max Load (lb/ft)	Apparent EI x 10 <sup>6</sup> (lb-in <sup>2</sup> )
	50	100	150	200	250	500	1000	2000		
12	0.001	0.001	0.002	0.002	0.003	0.006	0.012	0.024	14034	3.00
18	0.001	0.002	0.004	0.005	0.006	0.012	0.025	0.050	9356	4.88
24	0.002	0.005	0.007	0.010	0.012	0.024	0.049	0.098	7017	5.90
30	0.004	0.009	0.013	0.018	0.022	0.044	0.088	0.176	5614	6.40
36	0.007	0.015	0.022	0.029	0.036	0.073	0.146	0.292	4678	6.66
42	0.011	0.023	0.034	0.046	0.057	0.114	0.229	0.457	4010	6.75
48	0.017	0.034	0.051	0.068	0.085	0.169	0.338	0.677	3509	6.81
54	0.024	0.048	0.072	0.096	0.120	0.240	0.480		3119	6.83
60	0.033	0.066	0.099	0.131	0.164	0.328	0.657		2807	6.85
66	0.044	0.087	0.131	0.174	0.218	0.436			2552	6.87
72	0.057	0.113	0.170	0.226	0.283	0.565			2339	6.88

Span (inches)	UNIFORM LOAD in lb/ft <sup>2</sup>								Max Load (lb/ft <sup>2</sup> )	Apparent EI x 10 <sup>6</sup> (lb-in <sup>2</sup> )
	50	100	150	200	250	500	1000	2000		
12	<0.001	0.001	0.001	0.001	0.002	0.004	0.007	0.015	21051	3.00
18	0.001	0.002	0.004	0.005	0.006	0.012	0.023	0.047	14559	4.88
24	0.003	0.006	0.009	0.012	0.015	0.031	0.061	0.122	7136	5.90
30	0.007	0.014	0.021	0.027	0.034	0.069	0.137	0.275	4405	6.40
36	0.014	0.027	0.041	0.055	0.068	0.137	0.274	0.547	3161	6.66
42	0.025	0.050	0.075	0.100	0.125	0.250	0.500		2292	6.75
48	0.042	0.085	0.127	0.169	0.211	0.423			1746	6.81
54	0.068	0.135	0.203	0.270	0.338	0.675			1387	6.83
60	0.103	0.205	0.308	0.411	0.513				1124	6.85
66	0.150	0.300	0.450	0.599					928	6.87
72	0.212	0.424	0.636						779	6.88

Properties Per Foot of Width	# of Bars	Load Bar Depth	Bar Centers	Weight/sq ft
A = 4.66 in <sup>2</sup> I = 1.32 in <sup>4</sup> S = 1.76 in <sup>3</sup>	12	1.5"	1"	4.22

**T 10-18**  
**T Bearing Bar**  
**1" Thick**  
**18% Open**

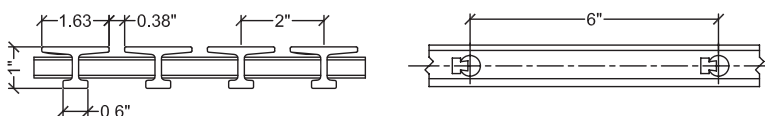

Span (inches)	CONCENTRATED LOAD in lb/ft of width								Max Load (lb/ft)	Apparent EI x 10 <sup>6</sup> (lb-in <sup>2</sup> )
	50	100	150	200	250	500	1000	2000		
12	0.002	0.004	0.006	0.008	0.009	0.019	0.038	0.075	5112	0.96
18	0.005	0.010	0.015	0.020	0.025	0.050	0.100	0.199	3408	1.22
24	0.011	0.022	0.033	0.044	0.055	0.109	0.218	0.436	2556	1.32
30	0.021	0.041	0.062	0.083	0.103	0.207	0.414		2045	1.36
36	0.035	0.070	0.106	0.141	0.176	0.352			1704	1.38
42	0.055	0.110	0.165	0.221	0.276	0.551			1461	1.40
48	0.081	0.162	0.243	0.325	0.406				1278	1.42

Span (inches)	UNIFORM LOAD in lb/ft <sup>2</sup>								Max Load (lb/ft <sup>2</sup> )	Apparent EI x 10 <sup>6</sup> (lb-in <sup>2</sup> )
	50	100	150	200	250	500	1000	2000		
12	0.001	0.002	0.004	0.005	0.006	0.012	0.023	0.047	10418	0.96
18	0.005	0.009	0.014	0.019	0.023	0.047	0.093	0.187	4562	1.22
24	0.014	0.027	0.041	0.055	0.068	0.136	0.273	0.545	2582	1.32
30	0.032	0.065	0.097	0.129	0.162	0.323	0.646		1626	1.36
36	0.066	0.132	0.198	0.264	0.330	0.660			1137	1.38
42	0.121	0.241	0.362	0.482	0.603				835	1.40
48	0.203	0.406	0.608						638	1.42

Properties Per Foot of Width	# of Bars	Load Bar Depth	Bar Centers	Weight/sq ft
A = 2.86 in <sup>2</sup> I = 0.37 in <sup>4</sup> S <sub>T</sub> = 1.00 in <sup>3</sup> S <sub>B</sub> = 0.59 in <sup>3</sup>	6	1"	2"	2.39



## PROGrate® Pultruded Phenolic Grating

**NOTE: These products are only available by special order. Minimum orders, extended lead times and special-order pricing will apply.** PROGrate® pultruded phenolic grating products are the ideal solution for decks, platforms, stairways and walkways that require superior resistance to fire, as well as low levels of smoke and toxic gas emissions. Our phenolic grating products are manufactured to the highest quality standards using fiberglass reinforcement and a phenolic resin system. These products are USCG level 2 approved.



### APPLICATIONS

- Offshore platforms
- Marine and ocean-going vessels
- Tunnels/public transportation
- Mining
- Public buildings
- Industrial/processing plants
- Refineries

### FEATURES

- High temperature and fire resistance
- Low smoke and toxic fume emissions
- Lightweight
- Low maintenance
- Easy to install



United States Coast Guard  
**APPROVED**



# PROGrate® Phenolic Grating Load and Deflection Data

## CONCENTRATED LOAD

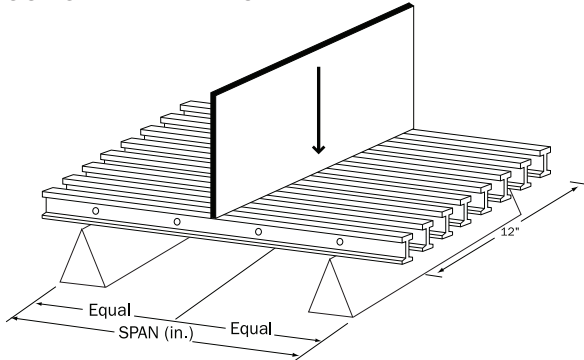

## UNIFORM LOAD

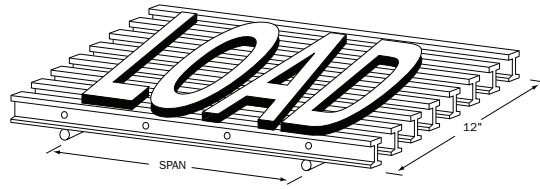

1. The following tables were developed in accordance with the test method developed by the Fiberglass Grating Manufacturers Council (FGMC) of the American Composites Manufacturers Association (ACMA) for the Fiberglass Grating Standard.
2. The designer should not exceed MAXIMUM RECOMMENDED load at any time. ULTIMATE CAPACITY represents MAX LOAD observed at initial fracture.
3. Walking loads for maintenance traffic are typically a live load of 50 PSF. Deflections for worker comfort are typically limited to 0.375" (3/8") or SPAN divided by 120 under full live load. For a firmer feel under full live load or a line load 250 lb/ft of width, limit deflections to 0.25" (1/4") or SPAN divided by 200.
4. The loads represented are for STATIC LOAD CONDITIONS at ambient temperature. Deflections for impact loads or dynamic loads will MULTIPLY the deflections shown by 2. Long term loads will result in added deflection due to creep in the material and will require higher factors of safety to ensure acceptable performance.
5. Deflections are limited to 0.5" (1/2") as recommended by the Fiberglass Grating Manufacturers Council of the American Composites Manufacturers Association.

**PROGrate® Pultruded Phenolic Grating**  
**USCG Approval #164.040/13/0**  
**I 15-60 PH**  
**I Bearing Bar**  
**1 1/2" Thick / 60% Open**

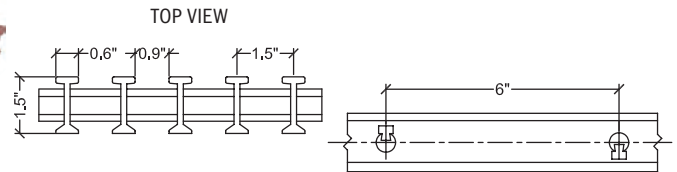

Span (inches)	CONCENTRATED LOAD in lb/ft of width								Max Load (lb/ft)	Apparent EI x 10 <sup>6</sup> (lb-in <sup>2</sup> )
	50	100	150	200	250	500	1000	2000		
12	0.001	0.002	0.003	0.004	0.005	0.010	0.020	0.040	6222	1.8
18	0.002	0.005	0.007	0.009	0.012	0.023	0.047	0.093	4148	2.6
24	0.005	0.009	0.014	0.018	0.023	0.045	0.090	0.180	3111	3.2
30	0.008	0.015	0.023	0.031	0.038	0.077	0.154	0.307	2489	3.66
36	0.012	0.024	0.036	0.048	0.060	0.121	0.242	0.484	2074	4.02
42	0.018	0.036	0.054	0.072	0.090	0.180	0.361		1778	4.28
44	0.020	0.040	0.060	0.080	0.099	0.199	0.398		1697	4.46
48	0.026	0.051	0.077	0.102	0.128	0.256	0.512		1556	4.5
54	0.036	0.073	0.109	0.145	0.181	0.363			1383	4.52

Span (inches)	UNIFORM LOAD in lb/ft <sup>2</sup>								Max Load (lb/ft <sup>2</sup> )	Apparent EI x 10 <sup>6</sup> (lb-in <sup>2</sup> )
	50	100	150	200	250	500	1000	2000		
12	0.001	0.001	0.002	0.002	0.003	0.006	0.012	0.025	15555	1.8
18	0.003	0.004	0.007	0.009	0.011	0.022	0.044	0.088	6057	2.6
24	0.006	0.011	0.017	0.022	0.028	0.056	0.112	0.225	3182	3.2
30	0.012	0.024	0.036	0.048	0.060	0.120	0.240	0.480	1992	3.66
36	0.023	0.045	0.068	0.091	0.113	0.227	0.453		1393	4.02
42	0.039	0.079	0.118	0.158	0.197	0.394			1014	4.28
44	0.046	0.091	0.137	0.182	0.228	0.456			927	4.46
48	0.064	0.128	0.192	0.256	0.320	0.640			778	4.5
54	0.102	0.204	0.306	0.408	0.510				615	4.52

Properties Per Foot of Width	# of Bars	Load Bar Width	Bar Centers	Weight/sq ft
A = 3.11 in <sup>2</sup> I = 0.88 in <sup>4</sup> S = 1.17 in <sup>3</sup>	8	0.6"	1.5"	3.06



# Product Availability

## PROGrid® Molded Grating

Type	Depth/Thickness	Grid Pattern	Available Panel Size	Weight/ Sq Ft	Open Area	Recommended Fasteners	Page	
<b>RECTANGULAR</b>								
	1"	Rectangular	1" x 4"	12' x 4'* / 10' X 3'*	2.61	68%	M-L-C	6
<b>SQUARE</b>								
ADA	1"	Square	¾" x ¾"	4' x 12'	4.06	44%	M-W	8
	1"	Square	1½" x 1½"	3' x 10' / 4' x 8' / 4' x 12'	2.50	69%	M-L-C	7
ADA	1½"	Square	¾" x ¾"	4' x 12'	4.75	44%	M-W	8
	1½"	Square	1½" x 1½"	3' x 10' / 3' x 12' / 4' x 8' / 4' x 12' / 5' x 10'	3.94	68%	M-L-C	7
	2"	Square	2" x 2"	4' x 12'	4.51	71%	M-L-C	7
<b>SQUARE COVERED</b>								
	1⅛"	Square Covered	1½" x 1½"	4' x 12'	2.73	N/A	W	9
	1⅝"	Square Covered	1½" x 1½"	4' x 6'	5.17	N/A	W	9

## PROGrid® Molded Grating – SPECIAL ORDER

Type	Depth/Thickness	Grid Pattern	Available Panel Size	Weight/ Sq Ft	Open Area	Recommended Fasteners	Page	
<b>RECTANGULAR</b>								
ADA	1½"	Rectangular	1" x 6"	4' x 12'	4.71	38%	M-L-C	26
	1½"	Rectangular	1½" x 6"	4' x 12'	4.42	55%	M-L-C	27
<b>SQUARE</b>								
	½"	Square	1½" x 1½"	4' x 12'	1.33	72%	M-L-C	27
	½"	Square	2" x 2"	4' x 12'	1.01	78%	M-L-C	27

## PROGrid® Molded Grating – High Load Capacity (HLC)

Type	Depth/Thickness	Grid Pattern	Available Panel Size	Weight/ Sq Ft	Open Area	Recommended Fasteners	Page	
<b>RECTANGULAR</b>								
HLC	1½"	Rectangular	1" x 2"	4' x 6'	6.21	48%	W	11
HLC	2"	Rectangular	1" x 2"	4' x 6'	8.40	48%	W	11

## PROGrid® Molded Stair Treads

Type	Depth/Thickness	Grid Pattern	Available Panel Size	Weight/ Sq Ft	Open Area	Recommended Fasteners	Page	
	1½"	Rectangular	1½" x 6"	24" x 144"	8.00	65%	M-L	17
	1½"	Square	1½" x 1½"	12" x 144"	4.00	68%	M-L	17
	1½"	Square	1½" x 1½"	25" x 144"	8.50	68%	M-L	18

\* Load bars run in the short dimensions, 3' or 4'.

# Product Availability

## PROGrate® Pultruded Grating

Series	Depth/Thickness	Load Bar Type/Spacing	Cross Rod Spacing	Available Panel Size	Weight/ Sq Ft	Open Area	Recommended Fasteners	Page
<b>T-BAR</b>								
T 20-50	2"	T / 2"	6"	3' x 20' / 4' x 20'	3.43	50%	M	14
<b>I-BAR</b>								
I 10-60	1"	I / 1½"	6"	3' x 20' / 4' x 20' / 3' x 24' / 4' x 24'	2.47	60%	M-L	15
I 15-60	1½"	I / 1½"	6"	3' x 20' / 4' x 20' / 3' x 24' / 4' x 24'	2.97	60%	M-L	15
I 10-83	1"	I / 1.9"	6"	3' x 20'	2.00	83%	L	15

## PROGrate® Pultruded Grating – SPECIAL ORDER

Series	Depth/Thickness	Load Bar Type/Spacing	Cross Rod Spacing	Available Panel Size	Weight/ Sq Ft	Open Area	Recommended Fasteners	Page
<b>T-BAR</b>								
T 10-18*†	1"	T / 2"	6"	Made to Order	2.39	18%	W	45
T 10-33*	1"	T / 1½"	6"	Made to Order	2.25	33%	W	28
T 10-35	1"	T / 2½"	6"	Made to Order	2.00	35%	W	29
T 10-50	1"	T / 2"	6"	Made to Order	1.81	50%	W	29
T 15-17*	1½"	T / 1.2"	6"	Made to Order	3.39	17%	W	29
T 15-33	1½"	T / 1½"	6"	Made to Order	2.81	33%	W	30
T 15-50	1½"	T / 2"	6"	Made to Order	2.23	50%	W	30
T 20-33*	2"	T / 1½"	6"	Made to Order	4.44	33%	M-L	31
<b>I-BAR</b>								
I 10-40*†	1"	I / 1"	6"	Made to Order	3.47	40%	M-L	45
I 10-50	1"	I / 1.2"	6"	Made to Order	2.97	50%	M-L	31
I 15-40*†	1½"	I / 1"	6"	Made to Order	4.22	40%	M-L	45
I 15-50	1½"	I / 1.2"	6"	Made to Order	3.60	50%	M-L	32
I 10-40-ADA*	1"	I / .52"	6"	Made to Order	4.08	40%	M-L	32
I 10-50-ADA*	1"	I / .63"	6"	Made to Order	3.50	50%	M-L	33
I 10-60-ADA*	1"	I / .78"	6"	Made to Order	2.92	60%	M-L	33
I 15-40-ADA*	1½"	I / .52"	6"	Made to Order	5.32	40%	M-L	34
I 15-50-ADA*	1½"	I / .63"	6"	Made to Order	4.64	50%	M-L	34
I 15-60-ADA*	1½"	I / .78"	6"	Made to Order	3.74	60%	M-L	35
I 30-40-ADA*	3"	I / 1"	3"	Made to Order	12.28	40%	W	35
I 30-50	3"	I / 1.2"	3"	Made to Order	10.34	50%	W	36
I 30-60	3"	I / 1½"	3"	Made to Order	8.40	60%	W	36

\* ADA Compliant

† VGBA Approved

# Product Availability

## PROGrate® Heavy Duty Pultruded Grating – SPECIAL ORDER

Series	Depth/ Thickness	Load Bar Type/Spacing	Cross Rod Spacing	Available Panel Size	Weight/ Sq Ft	Open Area	Recommended Fasteners	Page
HD 10-40*	1"	HD Bearing Bar / 1"	6"	Made to Order	5.84	40%	M-L	38
HD 10-50	1"	HD Bearing Bar / 1.2"	6"	Made to Order	4.94	50%	M-L	39
HD 10-60	1"	HD Bearing Bar / 1½"	6"	Made to Order	4.05	60%	M-L	39
HD 15-40*	1½"	HD Bearing Bar / 1"	6"	Made to Order	9.13	40%	M-L	39
HD 15-50	1½"	HD Bearing Bar / 1.2"	6"	Made to Order	7.69	50%	M-L	40
HD 15-60	1½"	HD Bearing Bar / 1½"	6"	Made to Order	6.25	60%	M-L	40
HD 20-40*	2"	HD Bearing Bar / 1"	6"	Made to Order	11.81	40%	W	41
HD 20-50	2"	HD Bearing Bar / 1.2"	6"	Made to Order	9.92	50%	W	41
HD 20-60	2"	HD Bearing Bar / 1½"	6"	Made to Order	8.03	60%	W	42
HD 25-40*	2½"	HD Bearing Bar / 1"	3"	Made to Order	14.48	40%	W	42
HD 25-50	2½"	HD Bearing Bar / 1.2"	3"	Made to Order	12.14	50%	W	43
HD 25-60	2½"	HD Bearing Bar / 1½"	3"	Made to Order	9.81	60%	W	43

## PROGrate® Pultruded Phenolic Grating – SPECIAL ORDER

Series	Depth/ Thickness	Load Bar Type/Spacing	Cross Rod Spacing	Available Panel Size	Weight/ Sq Ft	Open Area	Recommended Fasteners	Page
I 15-60-PH	1½"	I / 1½"	6"	Made to Order	3.06	60%	M-L	47

## PROGrate® Pultruded Stair Treads

Series	Depth/ Thickness	Load Bar Type/Spacing	Cross Rod Spacing	Available Panel Size	Weight/ Sq Ft	Open Area	Recommended Fasteners	Page
I 15-60	1½"	I / 1½"	6"	12" x 144"	2.97	60%	M-L	18
T 20-50	2"	T / 2"	6"	12" x 144"	3.43	50%	M-L	18

\* ADA Compliant



# Chemical Resistance Guide

Chemical Environment	% Concentration	Temp °F	PROGrid® Molded Grating			PROGrate® Pultruded Grating	
			VFR	IFR	GP	VFR	IFR
Acetic Acid	25	MAX	C	C	S	C	C
Acetic Acid	50	MAX	C	C	S	C	C
Aluminum Hydroxide	ALL	MAX	C	C	C	C	C
Ammonium Chloride	ALL	120	C	C	C	C	C
Ammonium Bicarbonate	15	120	C	C	S	C	S
Ammonium Bicarbonate	50	120	C	C	S	S	I
Ammonium Hydroxide	20	80	S	N	N	I	N
Ammonium Sulfate	ALL	120	C	C	C	C	S
Benzene	100	150	I	I	N	I	N
Benzoic Acid (SAT)	SAT	MAX	C	C	S	C	C
Borax (SAT)	SAT	MAX	C	C	S	C	S
Calcium Carbonate	ALL	MAX	C	C	S	C	C
Calcium Nitrate	ALL	MAX	C	C	C	C	C
Carbon Tetrachloride	100	80	I	N	N	I	N
Chlorine, Dry Gas	ALL	MAX	C	C	S	C	S
Chlorine Water (SAT)	SAT	120	C	I	N	I	N
Chromic Acid	50	150	I	N	N	I	N
Citric Acid	ALL	MAX	C	C	C	C	C
Copper Chloride	ALL	MAX	C	C	C	C	C
Copper Cyanide	ALL	140	C	S	I	S	I
Copper Nitrate	ALL	MAX	C	C	C	C	C
Ethanol	10	120	C	S	S	C	S
Ethanol	50	120	C	I	I	C	I
Ethylene Glycol	ALL	ISO	C	C	S	C	S
Ferric Chloride	100	MAX	C	C	C	C	C
Ferrous Chloride	ALL	MAX	C	C	C	C	C
Formaldehyde 0-50%	50	120	S	I	I	S	I
Gasoline	ALL	120	C	C	S	C	S
Glucose	ALL	120	C	C	C	C	C
Glycerin	100	MAX	C	C	S	C	S
Hydrobromic Acid	50	MAX	S	S	I	I	N
Hydrochloric Acid	10	MAX	C	S	S	S	S
Hydrochloric Acid	37	MAX	I	S	I	I	I
Hydrogen Peroxide	30	80	C	N	N	S	N
Lactic Acid	100	MAX	C	C	C	C	C
Lithium Chloride (SAT)	SAT	MAX	N	N	N	N	N
Magnesium Chloride	ALL	MAX	C	C	C	C	C
Magnesium Nitrate	ALL	MAX	C	C	C	C	C

Chemical Environment	% Concentration	Temp °F	PROGrid® Molded Grating			PROGrate® Pultruded Grating	
			VFR	IFR	GP	VFR	IFR
Magnesium Sulfate	ALL	MAX	C	C	C	C	C
Mercuric Chloride	ALL	MAX	C	C	C	C	C
Mercurous Chloride	ALL	MAX	C	C	S	C	S
Nickel Chloride	ALL	MAX	C	C	C	C	C
Nickel Sulfate	ALL	MAX	C	C	C	C	C
Nitric Acid	20	120	S	S	I	I	I
Oxalic Acid	ALL	150	C	C	S	C	S
Perchloric Acid	30	90	S	I	I	I	I
Phosphoric Acid	80	MAX	C	C	C	C	S
Potassium Chloride	ALL	MAX	C	C	C	C	C
Potassium Dichromate	ALL	MAX	C	C	C	C	C
Potassium Nitrate	ALL	MAX	C	C	C	C	C
Potassium Sulfate	ALL	MAX	C	C	C	C	C
Propylene Glycol	ALL	MAX	C	C	S	C	S
Sodium Acetate	ALL	MAX	C	C	C	C	C
Sodium Bisulfate	ALL	80	S	S	I	C	I
Sodium Bromide	ALL	80	C	C	C	C	C
Sodium Cyanide	ALL	80	C	I	I	S	I
Sodium Hydroxide	10	MAX	C	I	N	I	N
Sodium Hydroxide	50	MAX	S	N	N	N	N
Sodium Nitrate	ALL	MAX	C	C	C	C	C
Sodium Sulfate	ALL	MAX	C	C	C	C	C
Sulfuric Acid	10	MAX	C	S	S	C	S
Sulfuric Acid	25	MAX	C	S	S	S	I
Sulfuric Acid	75	100	C	I	I	I	N
Tartaric Acid	ALL	MAX	C	C	S	C	S
Vinegar	ALL	MAX	C	C	S	C	S
Water, Distilled	ALL	MAX	C	C	C	C	C
Zinc Nitrate	100	MAX	C	C	C	C	C
Zinc Sulfate	100	MAX	C	C	C	C	C

**C** = Continuous exposure of the grating to the chemical environment listed at the given temperature.

**S** = Frequent exposure of the grating to splashes and spills from the chemical environment listed at the given temperature.

**I** = Infrequent exposure of the grating to splashes and spills from the chemical environment at the given temperature and the spill immediately cleaned up or washed from the grating.

**N** = Not recommended for the concentrations and temperatures listed.

**T** = Test

MAX temperature is 185°F for molded VFR and pultruded VFR grating, 160°F for molded IFR and pultruded IFR grating, 150°F for molded GP grating.

If the chemical environment involves a combination of two or more chemicals, the above guidelines shall not apply.

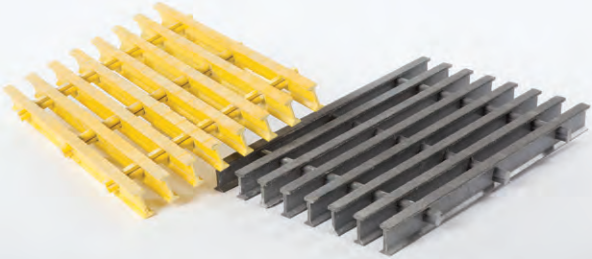

# EXPLORE OUR FULL LINE OF FRP SOLUTIONS

We offer a wide variety of structural products made of fiberglass-reinforced polymer, including PROForms® structural shapes, PROGrid® molded grating and PROGrate® pultruded grating. Our staff of skilled design, engineering and manufacturing professionals is dedicated to helping our customers maximize the benefits of FRP.

## PRODUCTS

- Structural shapes
- Grating
- Decking
- Stairs and handrails
- Ladders and cages
- Fabricated structures

## SERVICES

- Design and drafting
- Engineering
- Fabrication and CNC machining
- Secondary coating and painting
- Assembly and kitting
- In-house testing



**GRATING SYSTEMS INC. | 3005 SCOTT LN., WEST HAVEN, UT 84401**  
**PHONE: 800-368-4243 | FAX: 801-621-7311 | WEB: WWW.GRATINGSYSTEMS.COM**

The photographs and/or drawings in this literature are for illustrative purposes only. While every reasonable effort has been made to ensure the accuracy of this data, we are not responsible for any errors or omissions contained on these pages. Please verify any information in question with a sales representative. We reserve the right to make changes in specifications without notice and without incurring obligation.

© 2018 Bedford Reinforced Plastics. All rights reserved.